



NexAIoT Co., Ltd.

IoT Automation Solutions Business Group

Industrial Panel PC

IPPC 0811-B01 and IPPC 1211-B01

User Manual

CONTENTS

Preface

Copyright	iv
Disclaimer	iv
Acknowledgements	iv
Regulatory Compliance Statements	iv
Declaration of Conformity	iv
RoHS Compliance	v
Warranty and RMA	vi
Safety Information	ix
Installation Recommendations	ix
Safety Precautions	x
Technical Support and Assistance	xi
Conventions Used in this Manual	xi
Global Service Contact Information	xii
Package Contents	xiv
Ordering Information	xv

Chapter 1: Product Introduction

IPPC 0811-B01	1
IPPC 1211-B01	2
Specifications	3
Knowing Your IPPC Series	5
Rear	5
Rear Bottom	6
Mechanical Dimensions	7

IPPC 0811-B01	7
IPPC 1211-B01	8

Chapter 2: Jumpers and Connectors

Before You Begin	9
Precautions	9
Jumper Settings	10
Locations of the Jumpers and Connectors	11
Top View	11
Bottom View	12
Jumpers and DIP Switch Settings	13
RTC Clear Select	13
PWN Mode Power Select	13
AT/ATX Power Select	14
Connector Pin Definitions	15
External I/O Interfaces	15
USB 2.0 Port	15
USB 3.0 Port	15
LAN1 to LAN2 Ports	16
LAN3 to LAN4 Ports	17
Mini DisplayPort	18
Serial Console Port	18
Internal Connectors	19
EC Download Pin Header	19
Debug Port	19
LVDS Connector	20

PWR/HDD LED Connector	20
USB Connector	21
USB Connector	21
Light Sensor Connector	22
Power In Connector	22
PWRBT/RESET/Dimming Control Connector	23
FAN Connector	23
SATA Connector	24
SATA Power Connector	24
LVDS Inverter Connector	25
Battery Connector	25
PCIe M.2 Slot	26
Block Diagram	27

Chapter 3: System Setup

Installing a SATA M.2 Module	28
Installing a SO-DIMM Memory Module	31
Installing a SATA Hard Drive	34
Installing the Fan Kit (Optional)	38
Installing the Flush Mounting Kit (Optional)	41
IPPC 0811-B01 Flush Mount Mechanical Dimensions	42
IPPC 1211-B01 Flush Mount Mechanical Dimensions	43
VESA Mounting	44

Chapter 4: BIOS Setup

About BIOS Setup	45
When to Configure the BIOS	45
Default Configuration	46
Entering Setup	46
Legends	46

BIOS Setup Utility	48
Main	48
Advanced	49
Chipset	55
Security	57
Boot	57
Save & Exit	58

Appendix A: Power Consumption59

Appendix B: Watchdog

1.1 Command Register and Address Description:	60
1.2 Set up Watchdog Time Interval Description:	60
1.3 Read Watchdog Time Interval Description:	61
1.4 Reset Watchdog Time Interval Description:	61
1.5 Start Watchdog Description:	62
1.6 Stop Watchdog Description:	62

PREFACE

Copyright

This publication, including all photographs, illustrations and software, is protected under international copyright laws, with all rights reserved. No part of this manual may be reproduced, copied, translated or transmitted in any form or by any means without the prior written consent from NexAloT Co., Ltd.

Disclaimer

The information in this document is subject to change without prior notice and does not represent commitment from NexAloT Co., Ltd. However, users may update their knowledge of any product in use by constantly checking its manual posted on our website: <http://www.nexaiot.com>. NexAloT shall not be liable for direct, indirect, special, incidental, or consequential damages arising out of the use of any product, nor for any infringements upon the rights of third parties, which may result from such use. Any implied warranties of merchantability or fitness for any particular purpose is also disclaimed.

Acknowledgements

IPPC 0811-B01 and IPPC 1211-B01 are trademarks of NexAloT Co., Ltd. All other product names mentioned herein are registered trademarks of their respective owners.

Regulatory Compliance Statements

This section provides the FCC compliance statement for Class A devices and describes how to keep the system CE compliant.

Declaration of Conformity

FCC

This equipment has been tested and verified to comply with the limits for a Class A digital device, pursuant to Part 15 of FCC Rules. These limits are designed to provide reasonable protection against harmful interference when the equipment is operated in a commercial environment. This equipment generates, uses, and can radiate radio frequency energy and, if not installed and used in accordance with the instructions, may cause harmful interference to radio communications. Operation of this equipment in a residential area (domestic environment) is likely to cause harmful interference, in which case the user will be required to correct the interference (take adequate measures) at their own expense.

CE

The product(s) described in this manual complies with all applicable European Union (CE) directives if it has a CE marking. For computer systems to remain CE compliant, only CE-compliant parts may be used. Maintaining CE compliance also requires proper cable and cabling techniques.

RoHS Compliance



NexAloT RoHS Environmental Policy and Status Update

NexAloT is a global citizen for building the digital infrastructure. We are committed to providing green products and services, which are compliant with European Union RoHS (Restriction on Use of Hazardous Substance in Electronic Equipment) directive 2011/65/EU, to be your trusted green partner and to protect our environment.

RoHS restricts the use of Lead (Pb) < 0.1% or 1,000ppm, Mercury (Hg) < 0.1% or 1,000ppm, Cadmium (Cd) < 0.01% or 100ppm, Hexavalent Chromium (Cr6+) < 0.1% or 1,000ppm, Polybrominated biphenyls (PBB) < 0.1% or 1,000ppm, and Polybrominated diphenyl Ethers (PBDE) < 0.1% or 1,000ppm.

In order to meet the RoHS compliant directives, NexAloT has established an engineering and manufacturing task force to implement the introduction of green products. The task force will ensure that we follow the standard NexAloT development procedure and that all the new RoHS components and new manufacturing processes maintain the highest industry quality levels for which NexAloT are renowned.

The model selection criteria will be based on market demand. Vendors and suppliers will ensure that all designed components will be RoHS compliant.

How to recognize NexAloT RoHS Products?

For existing products where there are non-RoHS and RoHS versions, the suffix "(LF)" will be added to the compliant product name.

All new product models launched after January 2013 will be RoHS compliant. They will use the usual NexAloT naming convention.

Warranty and RMA

NexAloT Warranty Period

1. NexAloT makes products in accordance with the Industry standard and, NexAloT warrants that all the Industry-grade IPC and System products will be free from defect in neither material nor workmanship for twenty-four (24) months from the day of invoice issued.
2. For NexAloT Panel PC product lines (the APPC, MPPC series), they are also guaranteed against defect in materials and workmanship for the period of twenty-four (24) months in their motherboard design. For 3rd party parts, it follows with original suppliers' standard: 12 months for battery pack and LCD, 24 months for adaptor / add on modules (including GSM module, RFID module, and antenna).
3. If NexAloT determines customer's warranty claim is valid, NexAloT will repair or replace product(s) without additional charge for parts and labor. An extended Warranty Program will extend the warranty period of the product accordingly.

Warranty Coverage

The warranty applies only to products manufactured or distributed by NexAloT and its subsidiaries. This warranty covers all the products/shipments except for:

1. Any claimed defect, products that have been repaired or modified by persons who have not been authorized by NexAloT or, products which have been subjected to misuse, abuse, accident, improper installation, or usage not in accordance with the product instruction. NexAloT assumes no liability as a consequence of such events under the term of this warranty.

One example is the replacement of Tablet's or Hand-held's LCD display due to scratching stains or other degradation; these will not be covered under this warranty.

2. Damages caused by customers' delivery/shipping of the product or, product failure resulted from electrical power/voltage shock, or, installation of parts/components which are not supplied/approved by NexAloT in advance.
3. Third-party products:
 - a. Software, such as the device drivers,
 - b. External devices such as HDD, printer, scanner, mouse, LCD panel, battery, and so on,
 - c. Accessory/parts that were not approved by NexAloT and,
 - d. Accessory/parts were added to products after they were shipped from NexAloT.

Product will be treated as "Out of Warranty " if:

- a. It expires the warranted 24 months period from the day it was purchased.
- b. It had been altered by persons other than an authorized NexAloT service person or, which have been subjected to misuse, abuse, accident, or improper installation.
- c. It doesn't have the original NexAloT Serial Number labeling for NexAloT's warranty period identification or, tracking.

RMA that NexAloT has determined not to be covered by the warranty will be charged the NexAloT Standard Repair Fee for the repairing. If a RMA is determined to be not repairable, customer will be notified and product(s) may be returned to customer at their request; a minimum service fee may be charged however.

NexAloT Return Merchandise Authorization (RMA) Procedure

For the RMA (Return Merchandise Authorization) shipment, customer is responsible for packaging and shipping the product to the designated NexAloT service sites, with shipping charges prepaid by the customer. The original NexAloT shipping box should be used whenever possible. NexAloT shall pay for the return of the product to the customer's location. In case of expedited shipping request, an extra service charge shall be assessed and the customer is responsible for this extra return shipping charge.

1. Customers should enclose the "NexAloT RMA Service Form" with the returned products.
2. Customers need to write down all the information related to the problem on the " NexAloT RMA Service Form " when applying for the RMA service; information will help to understand the problem, including the fault description, on-screen messages, and pictures if possible.
3. Customers could send back the faulty product with or without the accessories and key parts such as the CPU and DIMM. If the key parts are included, please be noted clearly within the return form. NexAloT takes no responsibility for the parts which are not listed in the return form.
4. Customers hold the responsibility to ensure that the packing of defective products is durable enough to be resistant against further damage due to the transportation; damage caused by transportation is treated as " Out of Warranty " under our Warranty specification.
5. RMA product(s) returned by NexAloT to any location other than the

customer registered delivery address will incur an extra shipping charge, the customer is responsible for paying the extra shipping charges, duties, and taxes of this shipment.

Product Repairing

1. NexAloT will repair defective products covered under this limited warranty that are returned to NexAloT; if products do prove to be defective, they will be repaired during their warranty period unless other warranty terms have been specified.
2. NexAloT owns all parts removed from repaired products.
3. NexAloT will use parts made by various manufacturers in performing the repair.
4. The repaired products will be warranted subjected to the original warranty coverage and period only.
5. For products returned as defective but, proved to be no defect/fault after the RMA process, NexAloT reserves the right to claim for a NDF (No Defect Found) Service Charge.
6. NexAloT will issue RMA Report which included Repair Detailed Information to the customer when the defective products were repaired and returned.
7. In addition to the above, NexAloT may authorize Independent/Third-party suppliers to repair the defective products for NexAloT.

Out Of Warranty Service

There will be a service charge from NexAloT for the “Out Of Warranty” product service; they are the Basic Diagnostic Service Fee and the Advanced Component Replacement Fee respectively. And, if the product can not be repaired, NexAloT will either return the product to the customer or, just scrap it, followed by customer’s instruction.

1. Testing and Parts Replacement

NexAloT will have the following Handling Charges for those OoW products that returned:

- a. Basic Labor Cost and Testing Fee: as Table listed.
 - b. Parts Fee: NexAloT will charge for main IC chipsets such as the N.B., S.B., Super-IO, LAN, Sound, Memory, and so on.
 - c. 3rd-party Device Fee: products replacement for CPU, DIMM, HDD, Chassis, and UPS.
2. Out of Warranty product will have a three months warranty for the fixed issues. If the product failed with different problem within 3 months, they will still incur the service charge of “Out of Warranty” .
3. Out of Warranty “products will not be repaired without a signed PI from the customer, the agreement of the repair process.

Add-on card, 3rd Party Device and board level repair cost higher than new product prices, customer can abandon to sign PI to repair and, please contact with sales to buy new products.

Safety Information

Before installing and using the device, note the following precautions:

- Read all instructions carefully.
- Do not place the unit on an unstable surface, cart, or stand.
- Follow all warnings and cautions in this manual.
- When replacing parts, ensure that your service technician uses parts specified by the manufacturer.
- Avoid using the system near water, in direct sunlight, or near a heating device.
- The load of the system unit does not solely rely for support from the rackmounts located on the sides. Firm support from the bottom is highly necessary in order to provide balance stability.
- The computer is provided with a battery-powered real-time clock circuit. There is a danger of explosion if battery is incorrectly replaced. Replace only with the same or equivalent type recommended by the manufacturer. Discard used batteries according to the manufacturer's instructions.

Installation Recommendations

Ensure you have a stable, clean working environment. Dust and dirt can get into components and cause a malfunction. Use containers to keep small components separated.

Adequate lighting and proper tools can prevent you from accidentally damaging the internal components. Most of the procedures that follow require only a few simple tools, including the following:

- A Philips screwdriver
- A flat-tipped screwdriver
- A grounding strap
- An anti-static pad

Using your fingers can disconnect most of the connections. It is recommended that you do not use needle-nose pliers to disconnect connections as these can damage the soft metal or plastic parts of the connectors.

Safety Precautions

1. Read these safety instructions carefully.
2. Keep this User Manual for later reference.
3. Disconnect this equipment from any AC outlet before cleaning. Use a damp cloth. Do not use liquid or spray detergents for cleaning.
4. For plug-in equipment, the power outlet socket must be located near the equipment and must be easily accessible.
5. Keep this equipment away from humidity.
6. Put this equipment on a stable surface during installation. Dropping it or letting it fall may cause damage.
7. The openings on the enclosure are for air convection to protect the equipment from overheating. **DO NOT COVER THE OPENINGS.**
8. Make sure the voltage of the power source is correct before connecting the equipment to the power outlet.
9. Place the power cord in a way so that people will not step on it. Do not place anything on top of the power cord. Use a power cord that has been approved for use with the product and that it matches the voltage and current marked on the product's electrical range label. The voltage and current rating of the cord must be greater than the voltage and current rating marked on the product.
10. All cautions and warnings on the equipment should be noted.
11. If the equipment is not used for a long time, disconnect it from the power source to avoid damage by transient overvoltage.
12. Never pour any liquid into an opening. This may cause fire or electrical shock.
13. Never open the equipment. For safety reasons, the equipment should be opened only by qualified service personnel.
14. If one of the following situations arises, get the equipment checked by service personnel:
 - a. The power cord or plug is damaged.
 - b. Liquid has penetrated into the equipment.
 - c. The equipment has been exposed to moisture.
 - d. The equipment does not work well, or you cannot get it to work according to the user's manual.
 - e. The equipment has been dropped and damaged.
 - f. The equipment has obvious signs of breakage.
15. Do not place heavy objects on the equipment.
16. The unit uses a three-wire ground cable which is equipped with a third pin to ground the unit and prevent electric shock. Do not defeat the purpose of this pin. If your outlet does not support this kind of plug, contact your electrician to replace your obsolete outlet.
17. **CAUTION: DANGER OF EXPLOSION IF BATTERY IS INCORRECTLY REPLACED. REPLACE ONLY WITH THE SAME OR EQUIVALENT TYPE RECOMMENDED BY THE MANUFACTURER. DISCARD USED BATTERIES ACCORDING TO THE MANUFACTURER'S INSTRUCTIONS.**

Technical Support and Assistance

1. For the most updated information of NexAloT products, visit NexAloT's website at www.nexaiot.com.
2. For technical issues that require contacting our technical support team or sales representative, please have the following information ready before calling:
 - Product name and serial number
 - Detailed information of the peripheral devices
 - Detailed information of the installed software (operating system, version, application software, etc.)
 - A complete description of the problem
 - The exact wordings of the error messages

Warning!

1. Handling the unit: carry the unit with both hands and handle it with care.
2. Maintenance: to keep the unit clean, use only approved cleaning products or clean with a dry cloth.

Conventions Used in this Manual



Warning:

Information about certain situations, which if not observed, can cause personal injury. This will prevent injury to yourself when performing a task.



Caution:

Information to avoid damaging components or losing data.



Note:

Provides additional information to complete a task easily.

Global Service Contact Information

Headquarters

NEXCOM International Co., Ltd.

9F, No. 920, Chung-Cheng Rd.,
Zhonghe District, New Taipei City, 23586,
Taiwan, R.O.C.
Tel: +886-2-8226-7786
Fax: +886-2-8226-7782
www.nexcom.com

Asia

Taiwan

NexAIoT Headquarters

Industry 4.0 and Cloud Services

13F, No.916, Zhongzheng Rd.,
Zhonghe District, New Taipei City,
23586, Taiwan, R.O.C.
Tel: +886-2-8226-7796
Fax: +886-2-8226-7926
Email: sales@nexaiot.com
www.nexaiot.com

NexAIoT Co., Ltd.

Taichung Office

16F, No.250, Sec. 2, Chongde Rd.,
Beitun District,
Taichung City, 406, Taiwan, R.O.C.
Tel: +886-4-2249-1179
Fax: +886-4-2249-1172
Email: sales@nexaiot.com
www.nexaiot.com

NexCOBOT Taiwan Co., Ltd.

13F, No.916, Chung-Cheng Rd.,
Zhonghe District,
New Taipei City, 23586, Taiwan, R.O.C.
Tel: +886-2-8226-7786
Fax: +886-2-8226-7926
Email: sales@nexcobot.com
www.nexcobot.com

GreenBase Technology Corp.

13F, No.922, Chung-Cheng Rd.,
Zhonghe District,
New Taipei City, 23586, Taiwan, R.O.C.
Tel: +886-2-8226-7786
Fax: +886-2-8226-7900
Email: sales@nexcom.com.tw
www.nexcom.com.tw

EMBUX Technology Co., Ltd.

13F, No.916, Chung-Cheng Rd.,
Zhonghe District,
New Taipei City, 23586, Taiwan, R.O.C.
Tel: +886-2-8226-7786
Fax: +886-2-8226-7782
Email: sales@nexcom.com.tw
www.nexcom.com.tw

TMR Technology Corp.

13F, No.916, Chung-Cheng Rd.,
Zhonghe District,
New Taipei City, 23586, Taiwan, R.O.C.
Tel: +886-2-8226-7786
Fax: +886-2-8226-7782
Email: sales@nexcom.com.tw
www.nexcom.com.tw

China

NEXSEC Incorporated

5F, No.4, No.7 Fengxian Middle Rd.,
(Beike Industrial Park), Haidian District,
Beijing, 100094, China
Tel: +86-10-5704-2680
Fax: +86-10-5704-2681
Email: marketing@nexsec.cn
www.nexsec.cn

NEXCOM Shanghai

No.4, 16 Building,
Shanghai OMNI Tech & Science Park
No. 1699, Douhui Rd.,
Shanghai, 201108, China
Tel: +86-21-5278-5868
Fax: +86-21-3251-6358
Email: sales@nexcom.cn
www.nexcom.cn

NEXCOM Surveillance Technology Corp.

5F, Building C, ZhenHan Industrial Zone,
GanKeng Community, Buji Street,
LongGang District,
ShenZhen, 518112, China
Tel: +86-755-8364-7768
Fax: +86-755-8364-7738
Email: steveyang@nexcom.com.tw
www.nexcom.cn

NEXCOM United System Service

Room 603/604, Huiyinmingzun Plaza Bldg. 1,
No. 609, Yunlin East Rd.,
Shanghai, 200062, China
Tel: +86-21-5278-5868
Fax: +86-21-3251-6358
Email: renwang@nexcom.com.tw
www.nexcom.cn

NEXGOL Chongqing

1F, Building B4, Electronic 2nd Area,
(Phoenix Lake Industrial Park), Yongchuan Dist.,
Chongqing City, 402160, China
Tel: +86-23-4960-9080
Fax: +86-23-4966-5855
Email: sales@nexgol.com.cn
www.nexcobot.com/NexGOL

NexCOBOT China

Room 501, Building 1, Haichuang Building,
No.7 Qingyi Road, Guicheng Street,
Nanhai District, Foshan City,
Guangdong Province, 528314, China
Tel: +86-757-8625-7118
Email: sales@nexcobot.com
www.nexcobot.com.cn

Beijing NexGemo Technology Co.,Ltd.

5F, Gemotech Building, No.1, Development Rd.,
Changping International Information Industry Base,
Changping District,
Beijing, 102206, China
Tel: +86-10-8190-9328
Fax: +86-10-8190-9456
Email: sales@gemotech.cn
www.nexgemo.cn

Japan

NEXCOM Japan

9F, Tamachi Hara Bldg.,
4-11-5, Shiba Minato-ku,
Tokyo, 108-0014, Japan
Tel: +81-3-5419-7830
Fax: +81-3-5419-7832
Email: sales@nexcom-jp.com
www.nexcom-jp.com

America

USA NEXCOM USA

46665 Fremont Blvd.,
Fremont CA 94538, USA
Tel: +1-510-656-2248
Fax: +1-510-656-2158
Email: sales@nexcom.com
www.nexcomusa.com

NexCOBOT USA

2883 Bayview Drive,
Fremont CA 94538, USA
Tel: +1-510-362-0800
Fax: +1-510-656-2158
Email: sales@nexcobot.com
www.nexcobot.com

Europe

United Kingdom NEXCOM EUROPE

10 Vincent Avenue,
Crownhill Business Centre,
Milton Keynes, Buckinghamshire
MK8 0AB, United Kingdom
Tel: +44-1908-267121
Fax: +44-1908-262042
Email: sales.uk@nexcom.eu
www.nexcom.co.uk

Package Contents

Before continuing, verify that the package you received is complete. Your package should have all the items listed in the first table below.

Item	Description	Qty
1	Terminal Block 3-pin Phoenix Contact Plug	1
2	COM Port Cable	1
3	I Head Screw (Used for HDD) ***Only for IPPC 1211-B01***	4

Optional Items

Item	Description	Qty
1	Flush Mount Bracket	1
2	Cable Strain Relief	3
3	Fan	1
4	Sponge for Flush Mount Bracket	1 Set
5	Copper Pillar (Used for fan)	4
6	Flat Head Screw	6
7	Round Head Screw (Used for fan)	4



Note: Package contents may vary depending on your country region, some items may be optional. Please contact your local distributor for more information.



Flush Mount Bracket



Terminal Block
3-pin Phoenix
Contact Plug



Cable Strain Relief



Fan



Sponge for Flush
Mount Bracket/Set



COM Port Cable



Copper Pillar



Round Head Screw



Flat Head Screw



I Head Screw
(Only for IPPC 1211-B01)

Ordering Information

The following information below provides ordering information for the Industrial Panel PC series.

Barebone

- **IPPC 0811-B01 (P/N: 10II0081100X0)**
8" TFT WVGA 16:9 heavy industrial panel PC with Intel Atom® E3845 Processor 1.91GHz, multi-touch screen, 4GB DDR3L, M.2 64GB, 4 x LAN, 1 x COM, 1 x MiniDP
- **IPPC 1211-B01 (P/N: 10II0121100X0)**
12.1" TFT WXGA 16:9 heavy industrial panel PC with Intel Atom® E3845 Processor 1.91GHz, multi-touch screen, 4GB DDR3L, 4 x LAN, 1 x COM, 1 x MiniDP

Optional

- **12V, 60W AC/DC power adapter w/o power cord (P/N: 7400060054X00)**

CHAPTER 1: PRODUCT INTRODUCTION

IPPC 0811-B01

Overview



Key Features

- Intel Atom® E3845, Quad Core, 1.91GHz
- 8" PCAP multi-touch screen with AR coating
- 4 Gigabit Ethernet/Mini DisplayPort for external monitor
- Auto dimming function can be adjusted by ambient light
- DDR3L 4GB/M.2 SATA 64GB
- IP65 compliant front panel
- Built-in 24VDC isolated protection power input
- Mounting support: flush/VESA 75mm x 75mm

IPPC 1211-B01

Overview

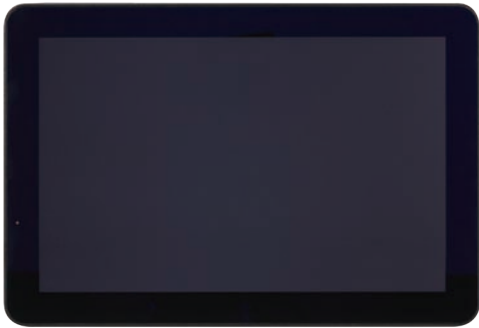

Key Features

- Intel Atom® E3845, Quad Core, 1.91GHz
- 12.1" PCAP multi-touch screen with AR coating
- 4 Gigabit Ethernet/Mini DisplayPort for external monitor
- Auto dimming function can be adjusted by ambient light
- DDR3L 4GB/1 swappable SSD tray for 2.5" SSD
- IP65 compliant front panel
- Built-in 24VDC isolated protection power input
- Mounting support: flush/VESA 75mm x 75mm

Specifications

Panel

IPPC 0811-B01

- LED size: 8", 16:9
- Resolution: WVGA 800 x 480
- Luminance: 600cd/m²
- Contrast ratio: 600
- LCD color: 16.2M
- Viewing angle: 60(U), 60(D), 70(L), 70(R)
- Backlight: LED

IPPC 1211-B01

- LED size: 12.1", 16:9
- Resolution: WXGA 1280 x 800
- Luminance: 600cd/m²
- Contrast ratio: 1000
- LCD color: 16.7M
- Viewing angle: 85(U), 85(D), 85(L), 85(R)
- Backlight: LED

Touch Screen

- Ten points P-Cap (projected capacitive touch)
- Touch light transmission: 89%
- Anti-scratch surface: 7H hardness with AR coating
- Touch interface: USB

System

- CPU: onboard Intel Atom® processor E3845, 1.91 GHz, 2M L2 Cache
- BIOS: AMI BIOS

- System memory: 1 x 204-pin DDR3L SO-DIMM socket, 4GB DDR3L (default), support up to 4GB DDR3L-1866, non-ECC and un-buffered
- Storage Device:
 - IPPC 0811-B01
 - 1 x SATA M.2 2242 Key B connector, 64G M.2 SATA (default)
 - 1 x SATA connector, support SATA 3Gb/s and SATA 6Gb/s
 - IPPC 1211-B01
 - 1 x SATA M.2 2242 Key B connector, M.2 2242 SATA storage (optional)
 - 1 x SATA connector for 1x swappable 2.5" SSD tray, support SATA 3Gb/s and SATA 6Gb/s, 2.5" SATA storage (optional)
- Watchdog timer: Watchdog timeout can be programmed by software from 1 second to 255 seconds and from 1 minute to 255 minutes (tolerance 15% under room temperature 25°C)
- H/W status monitor: monitoring system temperature, and voltage
- IPPC 1211-B01: Front LED indicator to show operating status
- Backlight control
 - Control button: increase brightness, decrease brightness, backlight on/off
 - Auto dimming function can be adjusted by ambient light sensor

Rear I/O

- Ethernet: 4 x RJ45
- 2nd DisplayPort: 1 x Mini DisplayPort
- USB: 1 x USB 2.0, 1 x USB 3.0
- COM #1: 1 x RJ45 output for RS232/422/485
- Power status LED
- DC power input connector: 3-pin Phoenix terminal blocks

Ethernet

- LAN chip: 4 x Intel® I210-IT Gigabit LAN
- Ethernet interface: 10/100/1000 Mbps
- Support wake up on LAN

Power Requirements

- Input voltage: 24VDC
- Reverse polarity protection
- Galvanic isolated
- Power consumption:
 - IPPC 0811-B01: 13W to 25W
 - IPPC 1211-B01: 22W to 30W

Mechanical & Environment

- Fanless system design
- Color
 - Pantone black RAL9005, powder painting for aluminum front bezel
 - Pantone 421C RAL7035, for aluminum back cover
- IP protection
 - IP65 front bezel
 - IP20 back system
- Mounting: VESA 75mm x 75mm/flush (optional)
- Vibration
 - 1.15Grms @ random condition, 1~200Hz, 1.5hr/axis (operating/non-operating)
- Shock
 - IEC 68 2-27
 - 20G @ wall mount, half sine, 11ms

- Operating temperature: -25°C to 60°C (Support up to 70°C when optional fan kit is installed)
- Storage temperature: -25°C to 75°C
- Operating humidity: 10%~90% relative humidity, non-condensing
- Dimension:
 - IPPC 0811-B01: 218.5 x 147.5 x 39.5 mm
 - IPPC 1211-B01: 307.5 x 209 x 39.9 mm
- Weight:
 - IPPC 0811-B01: 3kg
 - IPPC 1211-B01: 5kg

Certifications

- CE (including EN61000-6-2/EN61000-6-4)
- FCC Class A

OS Support

- Windows 10 64-bit

Knowing Your IPPC Series

Rear

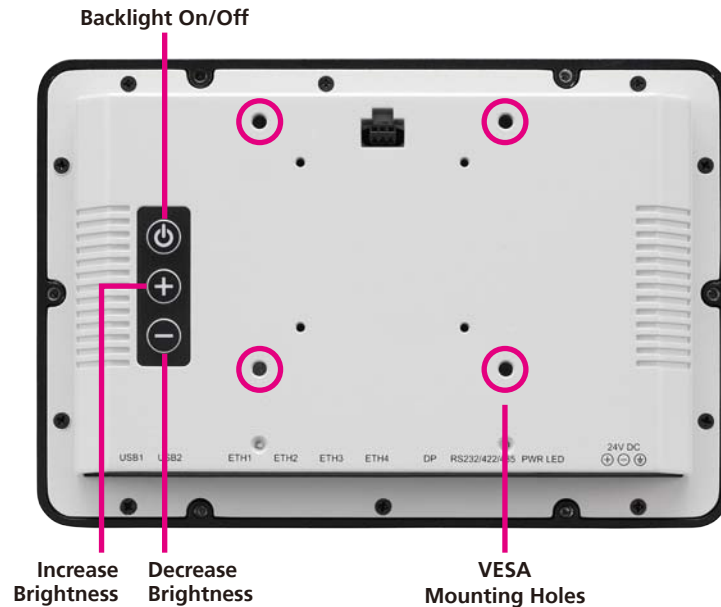

Backlight On/Off

Press to turn-on or turn-off the display.

Increase Brightness

Press to increase brightness of the screen.

Decrease Brightness

Press to decrease brightness of the screen.

VESA Mounting Holes

Mounting holes used for VESA mount installation (75 x 75mm).

Rear Bottom

IPPC 0811-B01

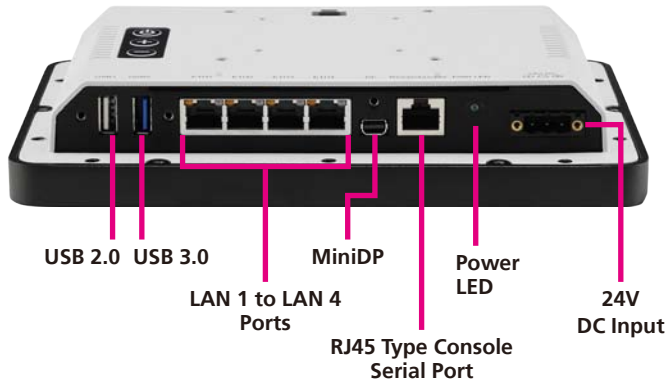

2.5" Storage Drive Tray (For IPPC 1211-B01)

Removable storage drive tray used to install a 2.5" HDD/SSD.

USB 2.0

Used to connect the system with USB 2.0/1.1 devices.

USB 3.0

Used to connect the system with USB 3.0/2.0 devices.

LAN 1 to LAN 4 Ports

Used to connect the system to a local area network.

Mini DisplayPort

Used to connect a Mini DisplayPort interface monitor.

RJ45 Type Console Serial Port

Used to connect console devices with RJ45 type connection.

Power LED

Indicates the power status of the system.

24V DC Input

Used to plug a DC power cord.

IPPC 1211-B01

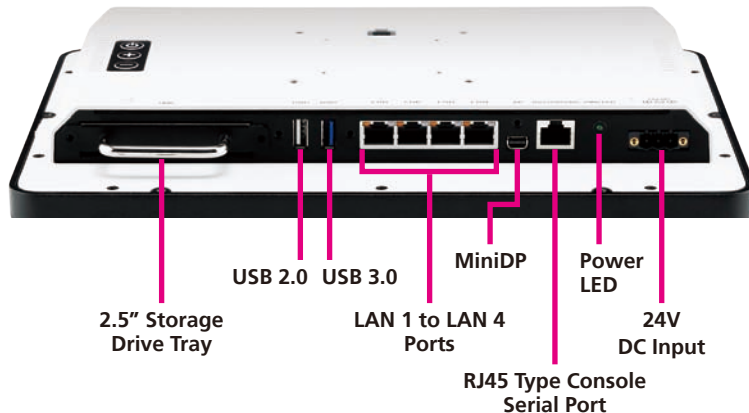

Mechanical Dimensions

IPPC 0811-B01

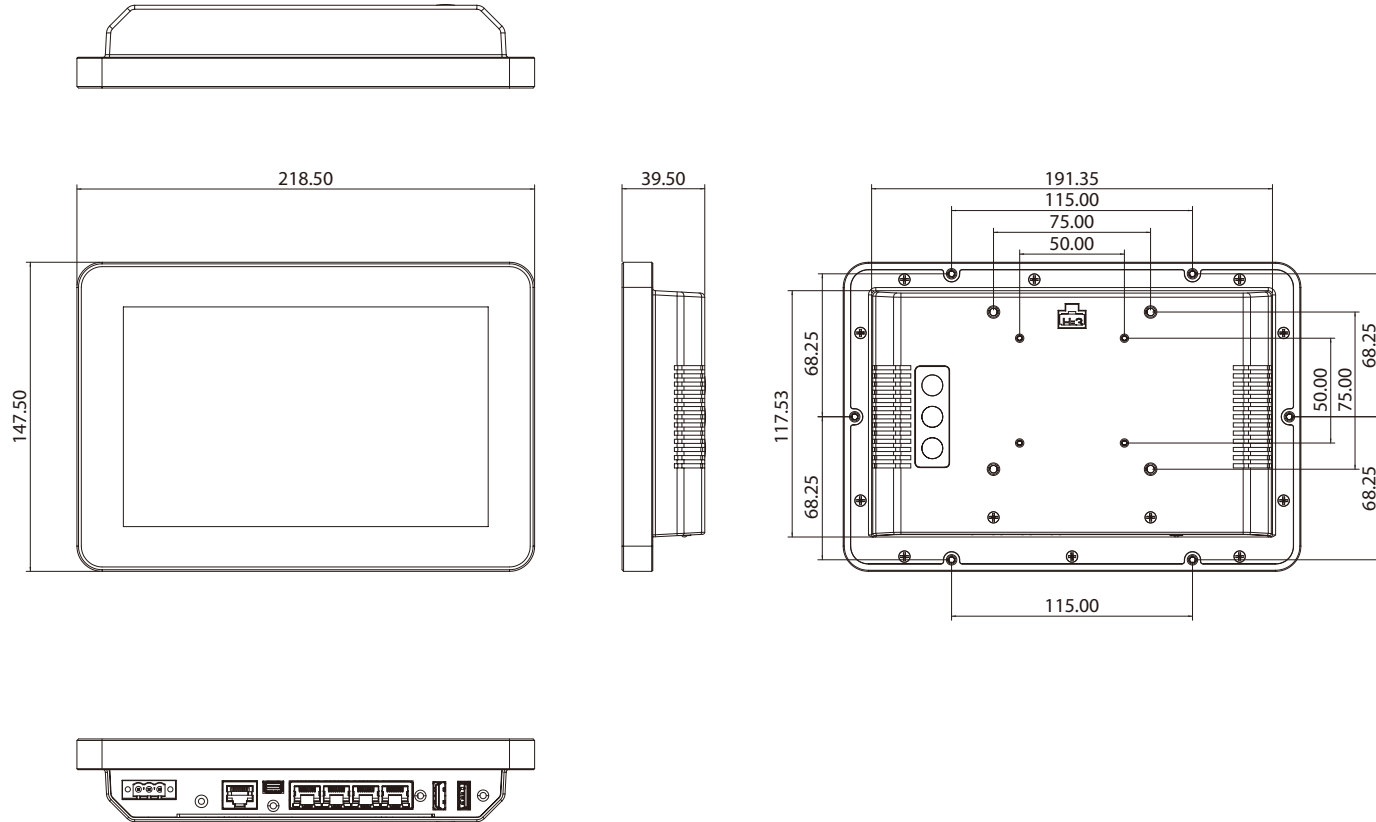

IPPC 1211-B01

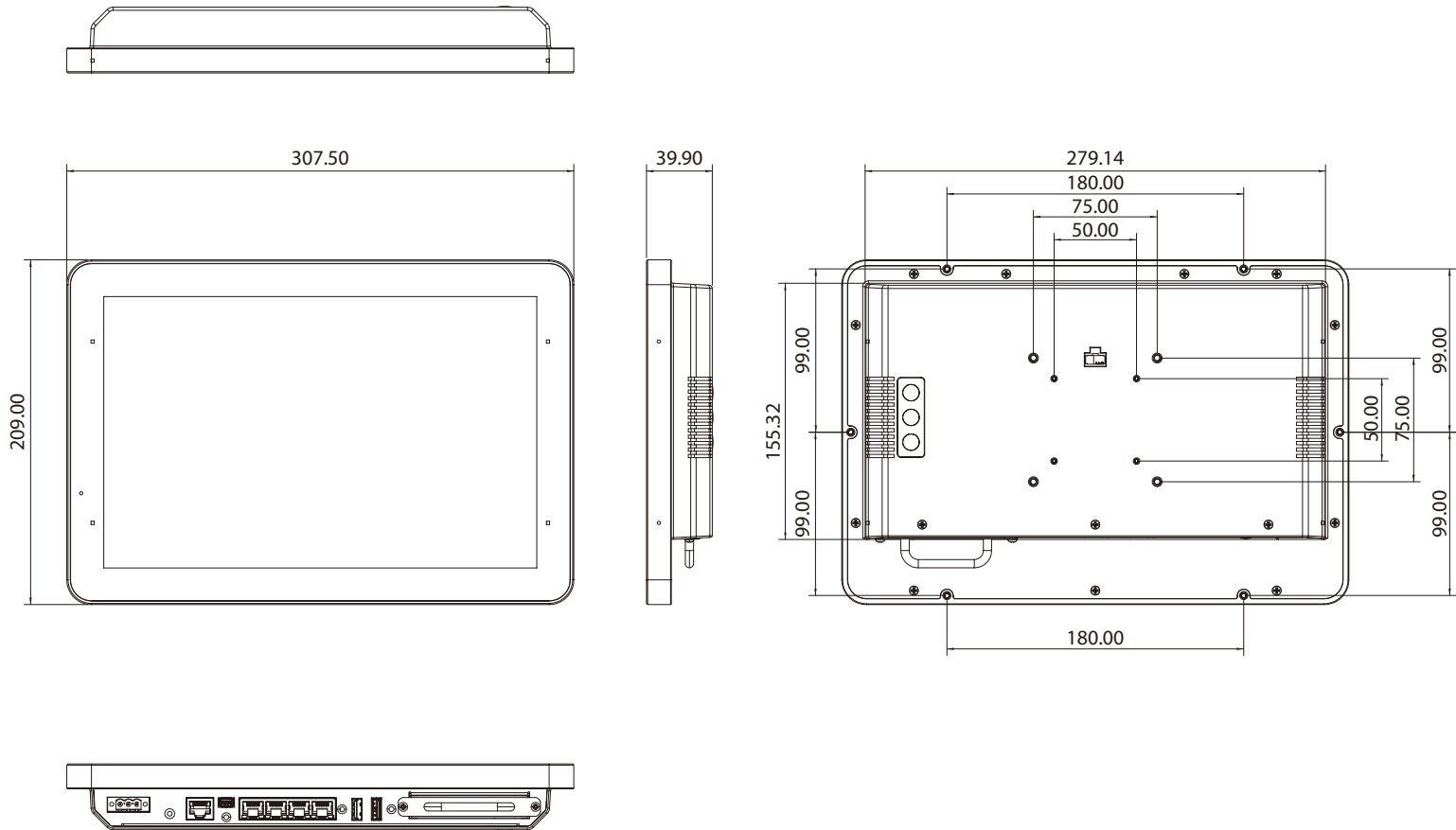

CHAPTER 2: JUMPERS AND CONNECTORS

This chapter describes how to set the jumpers and connectors on the motherboard. Note that information in this chapter applies to the IPPC 0811-B01 and IPPC 1211-B01 series.

Before You Begin

- Ensure you have a stable, clean working environment. Dust and dirt can get into components and cause a malfunction. Use containers to keep small components separated.
- Adequate lighting and proper tools can prevent you from accidentally damaging the internal components. Most of the procedures that follow require only a few simple tools, including the following:
 - A Philips screwdriver
 - A flat-tipped screwdriver
 - A set of jewelers screwdrivers
 - A grounding strap
 - An anti-static pad
- Using your fingers can disconnect most of the connections. It is recommended that you do not use needle-nosed pliers to disconnect connections as these can damage the soft metal or plastic parts of the connectors.
- Before working on internal components, make sure that the power is off. Ground yourself before touching any internal components, by touching a metal object. Static electricity can damage many of the electronic

components. Humid environments tend to have less static electricity than dry environments. A grounding strap is warranted whenever danger of static electricity exists.

Precautions

Computer components and electronic circuit boards can be damaged by discharges of static electricity. Working on computers that are still connected to a power supply can be extremely dangerous.

Follow the guidelines below to avoid damage to your computer or yourself:

- Always disconnect the unit from the power outlet whenever you are working inside the case.
- If possible, wear a grounded wrist strap when you are working inside the computer case. Alternatively, discharge any static electricity by touching the bare metal chassis of the unit case, or the bare metal body of any other grounded appliance.
- Hold electronic circuit boards by the edges only. Do not touch the components on the board unless it is necessary to do so. Don't flex or stress the circuit board.
- Leave all components inside the static-proof packaging that they shipped with until they are ready for installation. Use correct screws and do not over tighten screws.

Jumper Settings

A jumper is the simplest kind of electric switch. It consists of two metal pins and a cap. When setting the jumpers, ensure that the jumper caps are placed on the correct pins. When the jumper cap is placed on both pins, the jumper is short. If you remove the jumper cap, or place the jumper cap on just one pin, the jumper is open.

Refer to the illustrations below for examples of what the 2-pin and 3-pin jumpers look like when they are short (on) and open (off).

Two-Pin Jumpers: Open (Left) and Short (Right)

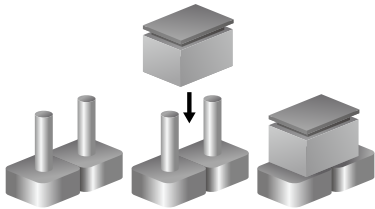

Three-Pin Jumpers: Pins 1 and 2 are Short

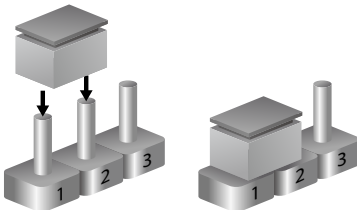

Locations of the Jumpers and Connectors

Top View

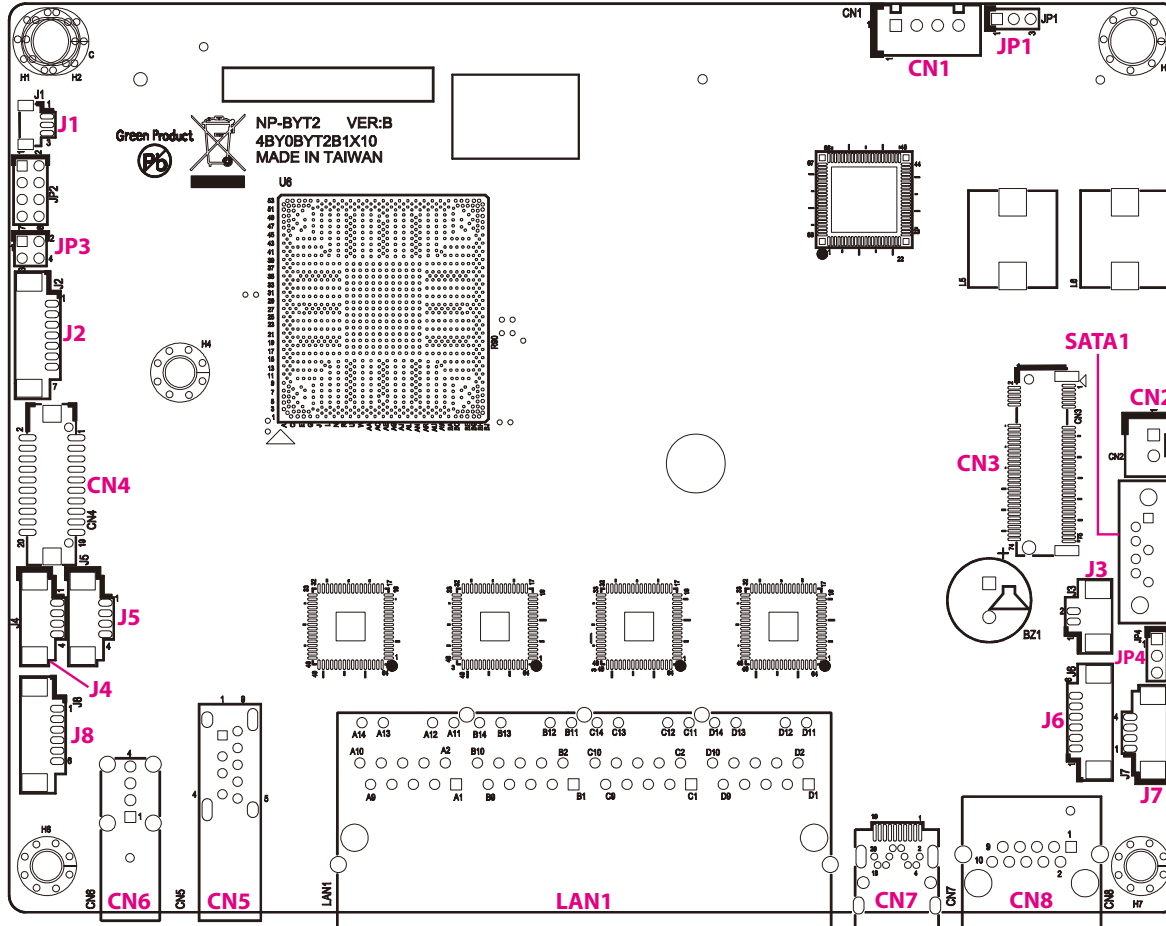

Bottom View

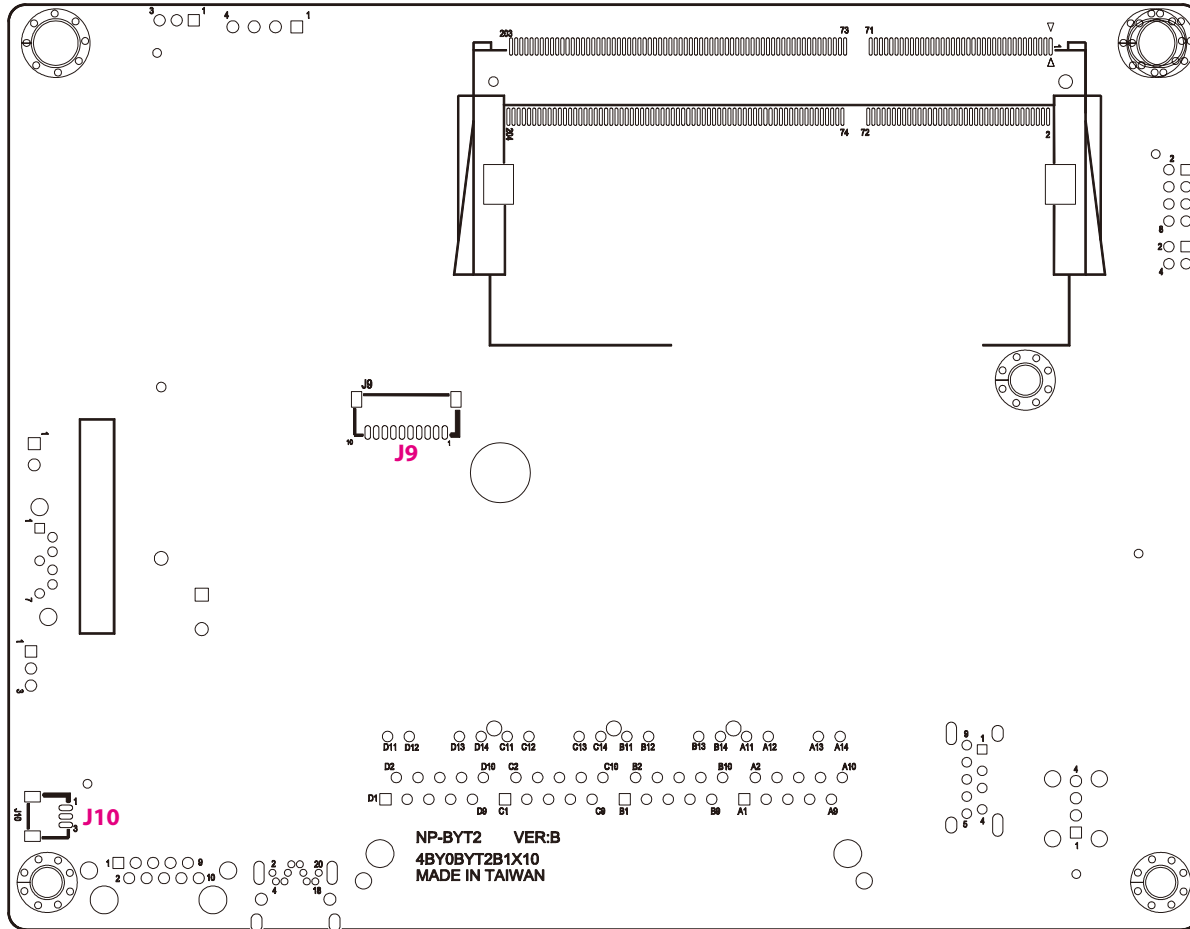

Jumpers and DIP Switch Settings

RTC Clear Select

Connector type: 1x3 3-pin header, 2.0mm pitch

Connector location: JP4



Pin	Settings
1-2 On	Normal
2-3 On	RTC Clear

1-2 On: default

PWN Mode Power Select

Connector type: 2x2 4-pin header, 2.0mm pitch

Connector location: JP3

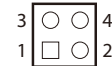

Pin	Settings
1-2 On	VCC3
3-4 On	VCC5

1-2 On: default

AT/ATX Power Select

Connector type: 1x3 3-pin header, 2.0mm pitch

Connector location: JP1



Pin	Settings
1-2 On	AT Mode
2-3 On	ATX Mode

2-3 On: default

Pin	Definition
1	AUTO (AT MODE)
2	PWRBT In
3	Manual (ATX MODE)

Connector Pin Definitions

External I/O Interfaces

USB 2.0 Port

Connector type: USB 2.0 port, Type A

Connector location: CN6

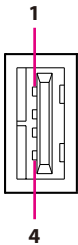

Pin	Definition	Pin	Definition
1	5V	2	USB1N
3	USB1P	4	GND
MH1	CHASSIS_GND	MH2	CHASSIS_GND
MH3	CHASSIS_GND		

USB 3.0 Port

Connector type: USB 3.0 port, Type A

Connector location: CN5



Pin	Definition	Pin	Definition
1	5V	2	USB0N
3	USB0P	4	GND
5	USB3_RX0N	6	USB3_RX0P
7	GND	8	USB3_TX0N
9	USB3_TX0P	MH1	CHASSIS_GND
MH2	CHASSIS_GND		

LAN1 to LAN2 Ports

Connector type: RJ45 port with LEDs

Connector location: LAN1

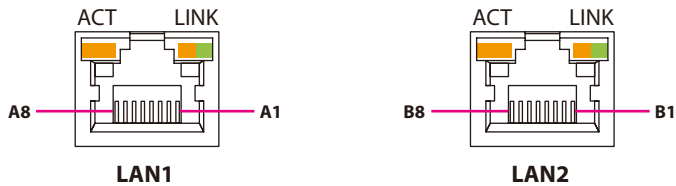

LAN1

Pin	Definition	Pin	Definition
A1	LAN1_MDIOP	A2	LAN1_MDI0N
A3	LAN1_MDI1P	A4	LAN1_MDI1N
A5	LAN1_TCTG	A6	LAN1_TCT
A7	LAN1_MDI2P	A8	LAN1_MDI2N
A9	LAN1_MDI3P	A10	LAN1_MDI3N
A11	LAN1_LEDACT#	A12	3VSB
A13	LAN1_LINK1G#	A14	LAN1_LINK100#
MH1	CHASSIS_GND	NH1	CHASSIS_GND

LAN2

Pin	Definition	Pin	Definition
B1	LAN2_MDIOP	B2	LAN2_MDI0N
B3	LAN2_MDI1P	B4	LAN2_MDI1N
B5	LAN2_TCTG	B6	LAN2_TCT
B7	LAN2_MDI2P	B8	LAN2_MDI2N
B9	LAN2_MDI3P	B10	LAN2_MDI3N
B11	LAN2_LEDACT#	B12	3VSB
B13	LAN2_LINK1G#	B14	LAN2_LINK100#
MH2	CHASSIS_GND	NH2	CHASSIS_GND

LAN3 to LAN4 Ports

Connector type: RJ45 port with LEDs

Connector location: LAN1

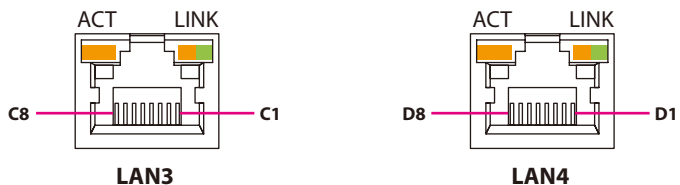

LAN3

Pin	Definition	Pin	Definition
C1	LAN3_MDI0P	C2	LAN3_MDI0N
C3	LAN3_MDI1P	C4	LAN3_MDI1N
C5	LAN3_TCTG	C6	LAN3_TCT
C7	LAN3_MDI2P	C8	LAN3_MDI2N
C9	LAN3_MDI3P	C10	LAN3_MDI3N
C11	LAN3_LEDACT#	C12	3VSB
C13	LAN3_LINK1G#	C14	LAN3_LINK100#
MH3	CHASSIS_GND		

LAN4

Pin	Definition	Pin	Definition
D1	LAN4_MDI0P	D2	LAN4_MDI0N
D3	LAN4_MDI1P	D4	LAN4_MDI1N
D5	LAN4_TCTG	D6	LAN4_TCT
D7	LAN4_MDI2P	D8	LAN4_MDI2N
D9	LAN4_MDI3P	D10	LAN4_MDI3N
D11	LAN4_LEDACT#	D12	3VSB
D13	LAN4_LINK1G#	D14	LAN4_LINK100#
MH4	CHASSIS_GND	MH5	CHASSIS_GND

Mini DisplayPort

Connector type: Mini DisplayPort

Connector location: CN7

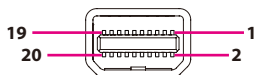

Pin	Definition	Pin	Definition
1	GND	2	DP_HPD
3	M_DDI1TX0P	4	DP_CONFIG1
5	M_DDI1TX0N	6	DP_CONFIG2
7	GND	8	GND
9	M_DDI1TX1P	10	M_DDI1TX3P
11	M_DDI1TX1N	12	M_DDI1TX3N
13	GND	14	GND
15	M_DDI1TX2P	16	AUX_SW_P
17	M_DDI1TX2N	18	AUX_SW_N
19	DP_RETURN	20	3.3V
MH1	CHASSIS_GND	MH2	CHASSIS_GND
MH3	CHASSIS_GND	MH4	CHASSIS_GND

Serial Console Port

Connector type: RJ45 port

Connector location: CN8

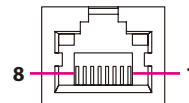

Pin	Definition	Pin	Definition
1	NC	2	SP1_DCD
3	SP1_DSR	4	SP1_RXD
5	SP1_RTS	6	SP1_TXD
7	SP1_CTS	8	SP1_DTR
9	GND	10	SP1_RI
MH1	GND	MH2	GND

Internal Connectors

EC Download Pin Header

Connector type: 1x3 3-pin header, 1.0mm pitch

Connector location: J10



Pin	Definition	Pin	Definition
1	EC_SMB_CLK	2	EC_SMB_DATA
3	GND	MH1	CHASSIS_GND
5	CHASSIS_GND		

Debug Port

Connector type: 1x10 10-pin header, 1.0mm pitch

Connector location: J9



Pin	Definition	Pin	Definition
1	VCC3	2	VCC3
3	LPC_LAD0	4	LPC_LAD1
5	LPC_LAD2	6	LPC_LAD3
7	LPC_FRAME#	8	LPC_CLK1_DEBUG
9	PLTRST_3P3#	10	GND
MH1	GND	MH2	GND

LVDS Connector

Connector type: 2x10 20-pin header, 1.25mm pitch

Connector location: CN4



Pin	Definition	Pin	Definition
1	VCC5_VDD	2	VCC5_VDD
3	VCC3_VDD	4	LVDS_DAT1N
5	LVDS_DAT0N	6	LVDS_DAT1P
7	LVDS_DAT0P	8	VCC3_VDD
9	GND	10	LVDS_CLK1N
11	LVDS_DAT2N	12	LVDS_CLK1P
13	LVDS_DAT2P	14	GND
15	GND	16	12V
17	LVDS_DAT3N	18	12V
19	LVDS_DAT3P	20	GND
MH1	GND	MH2	GND

PWR/HDD LED Connector

Connector type: 1x4 4-pin header, 1.25mm pitch

Connector location: J7

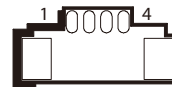

Pin	Definition	Pin	Definition
1	PWRLED#	2	PWRLED
3	HDD_LED#	4	HDD_LED
MH1	GND	MH2	GND

USB Connector

Connector type: 1x4 4-pin header, 1.25mm pitch

Connector location: J5

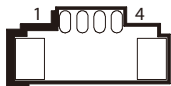

Pin	Definition	Pin	Definition
1	5VSB	2	USB2N
3	USB2P	4	GND
MH1	GND	MH2	GND

USB Connector

Connector type: 1x4 4-pin header, 1.25mm pitch

Connector location: J4

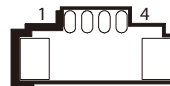

Pin	Definition	Pin	Definition
1	5VSB	2	USB3N
3	USB3P	4	GND
MH1	GND	MH2	GND

Light Sensor Connector

Connector type: 1x6 6-pin header, 1.25mm pitch

Connector location: J6

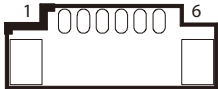

Pin	Definition	Pin	Definition
1	NC	2	3VSB
3	GND	4	EC_I2C_DATA
5	EC_I2C_CLK	6	INT
MH1	GND	MH2	GND

Power In Connector

Connector type: 1x4 4-pin header, 2.5mm pitch

Connector location: CN1



Pin	Definition	Pin	Definition
1	GND	2	GND
3	12VSB	4	12VSB

PWRBT/RESET/Dimming Control Connector

Connector type: 1x6 6-pin header, 1.25mm pitch

Connector location: J8

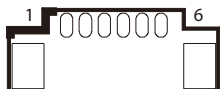

Pin	Definition	Pin	Definition
1	ATXBT#	2	GND
3	EC_BLUP	4	EC_BLDN
5	RSTBTN#	6	GND
MH1	GND	MH2	GND

FAN Connector

Connector type: 1x3 3-pin header, 1.0mm pitch

Connector location: J1



Pin	Definition	Pin	Definition
1	GND	2	FAN_12V
3	FAN_12V_FB		

SATA Connector

Connector type: Standard Serial ATA 7P (1.27mm, SATA-M-180)

Connector location: SATA1

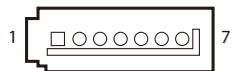

Pin	Definition	Pin	Definition
1	GND	2	SATA_TXP1
3	SATA_TXN1	4	GND
5	SATA_RXN1	6	SATA_RXP1
7	GND		

SATA Power Connector

Connector type: 1x2 2-pin header, JST 2.5mm pitch

Connector location: CN2



Pin	Definition
1	5V
2	GND

LVDS Inverter Connector

Connector type: 1x7 7-pin header, 1.25mm pitch

Connector location: J2



Pin	Definition	Pin	Definition
1	5V	2	12V
3	12V	4	BKLTCTRL
5	INV_GND	6	INV_GND
7	BKLTEN	MH1	INV_GND
MH2	INV_GND		

Battery Connector

Connector type: 1x2 2-pin header, JST 2.5mm pitch

Connector location: J3



Pin	Definition
1	5V
2	GND

PCIe M.2 Slot

Connector location: CN3

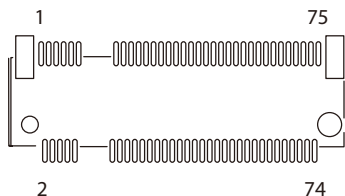

Pin	Definition	Pin	Definition
1	PCIE_M2_CONFIG3	2	VCC3
3	NC	4	VCC3
5	NC	6	NC
7	NC	8	NC
9	NC	10	PCIE_M2_DAS_DSS#
11	NC	20	NC
21	PCIE_M2_CONFIG0	22	NC
23	NC	24	NC
25	NC	26	NC
27	NC	28	NC
29	NC	30	NC
31	NC	32	NC
33	NC	34	NC
35	NC	36	NC
37	NC	38	PCIE_M2_DEVSLP
39	NC	40	NC
41	SATA_RXP0	42	NC

Pin	Definition	Pin	Definition
43	SATA_RXN0	44	NC
45	NC	46	NC
47	SATA_TXN0	48	NC
49	SATA_TXP0	50	NC
51	NC	52	NC
53	NC	54	NC
55	NC	56	PCIE_M2_Z01
57	NC	58	PCIE_M2_Z02
59	NC	60	NC
61	NC	62	NC
63	NC	64	NC
65	NC	66	NC
67	NC	68	NC
69	PCIE_M2_CONFIG1	70	VCC3
71	NC	72	VCC3
73	NC	74	VCC3
75	PCIE_M2_CONFIG2	MH1	GND
MH2	GND	MH3	NC

Block Diagram

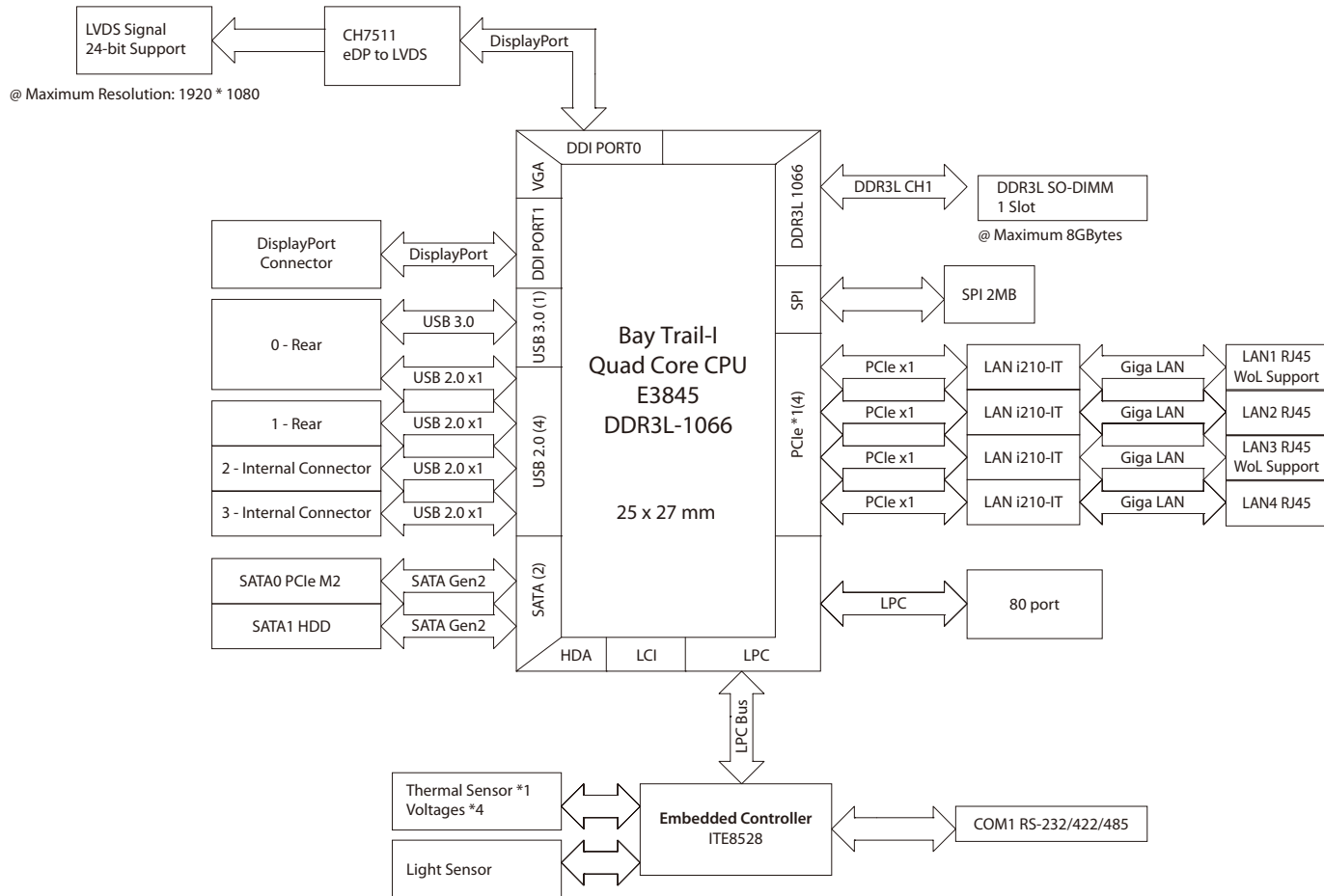

CHAPTER 3: SYSTEM SETUP

Installing a SATA M.2 Module



Prior to removing the chassis cover, make sure the unit's power is off and disconnected from the power sources to prevent electric shock or system damage.

1. Remove the screws around the chassis cover.

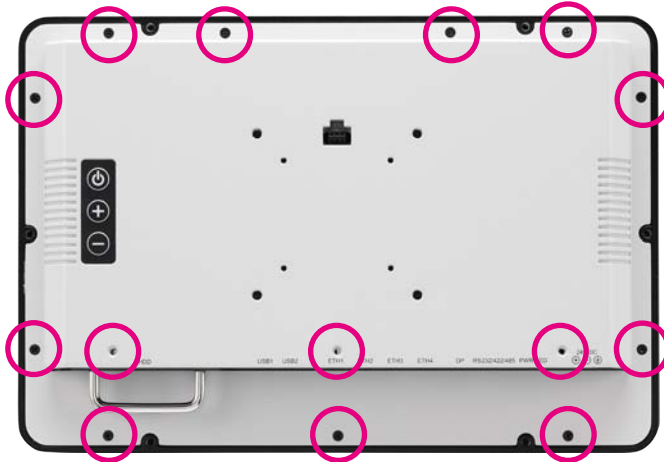

2. Remove the HDD tray.

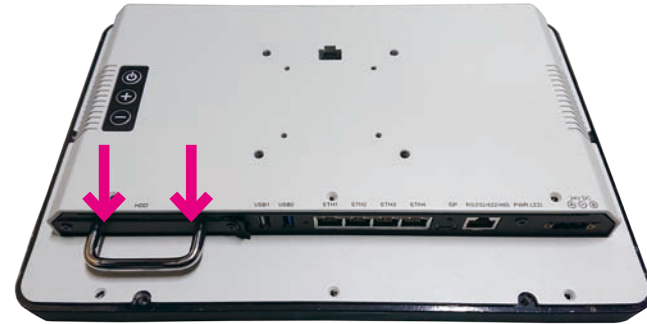

3. Lift up the back cover.



4. Remove the cable connectors that are circled below from the mainboard.

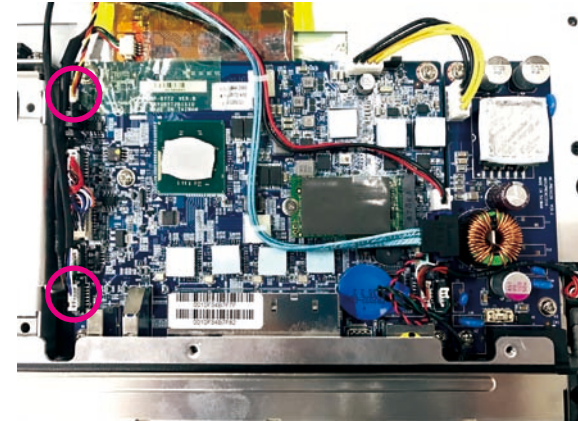

5. Install the SATA M.2 module into the M.2 slot.

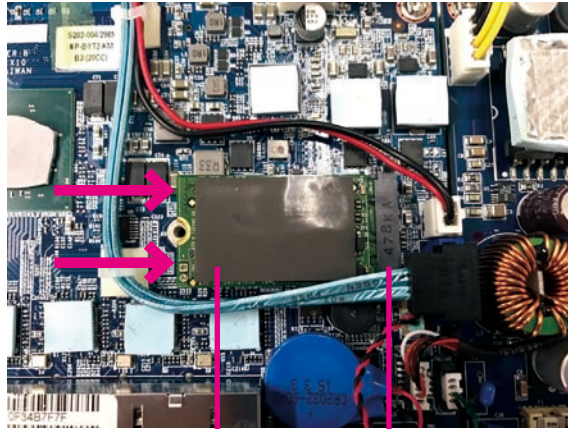

SATA M.2 Module

M.2 Slot

6. Secure the module with mounting screws.

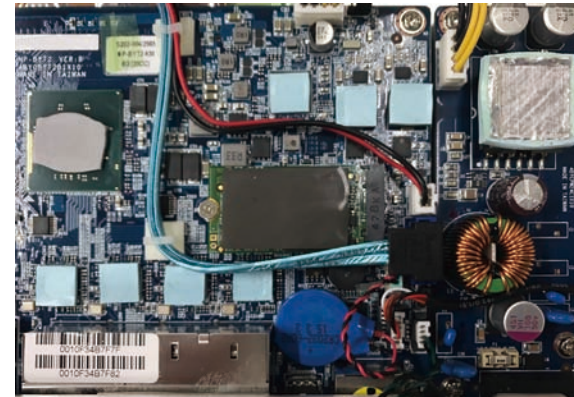
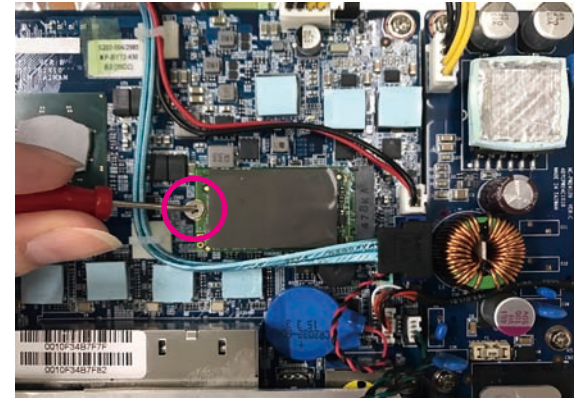

Installing a SO-DIMM Memory Module

1. Remove the screws around the chassis cover.

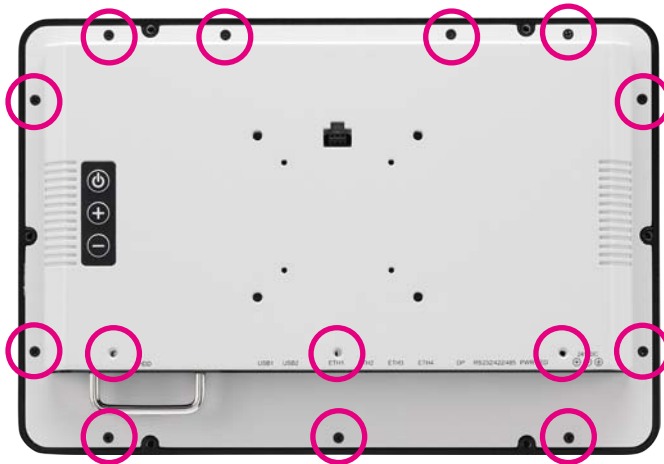

2. Remove the HDD tray.



3. Lift up the back cover.



4. Remove the cable connectors that are circled below from the mainboard.

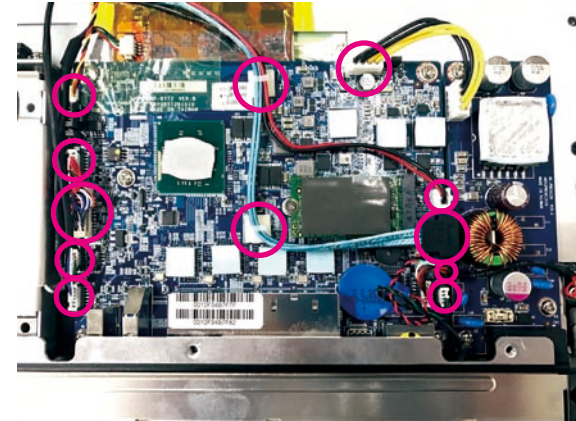

5. Remove the mainboard from the housing.

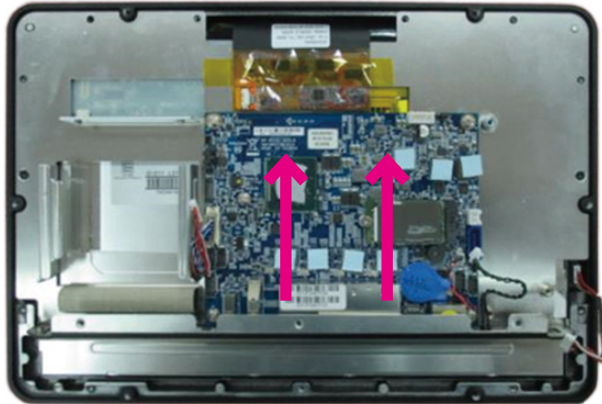

6. Locate the SO-DIMM slot on the back of the mainboard and install a SO-DIMM module into the slot.



Installing a SATA Hard Drive

1. Remove the screws around the chassis cover.

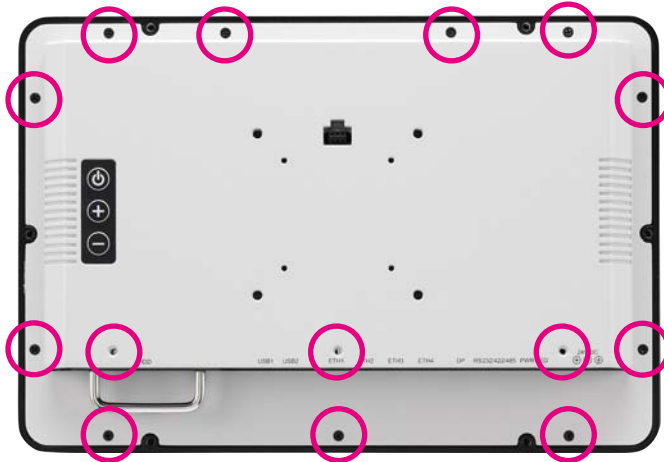

2. Remove the HDD tray.



3. Lift up the back cover.



4. Place the SATA hard drive on the HDD tray.



5. Fix screws into the mounting holes on the bottom of the HDD tray to secure the SATA drive in place.



6. Slide the HDD tray back into the system.

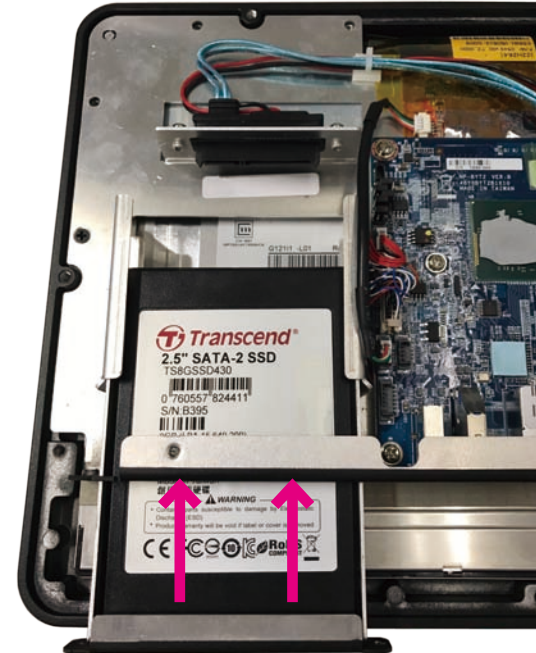

7. Make sure the rear connections on the SATA drive is firmly seated into the SATA connectors circled below.



Installing the Fan Kit (Optional)

The fan kit contains the following items:

- Fan x 1
- Copper Pillar x 4
- Round Head Screw x 4



Fan



Copper Pillar



Round Head Screw

1. Fix the copper pillars on the mounting holes at the back of the system.

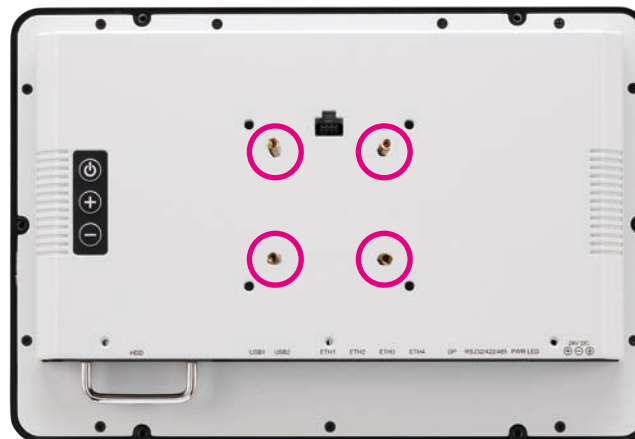
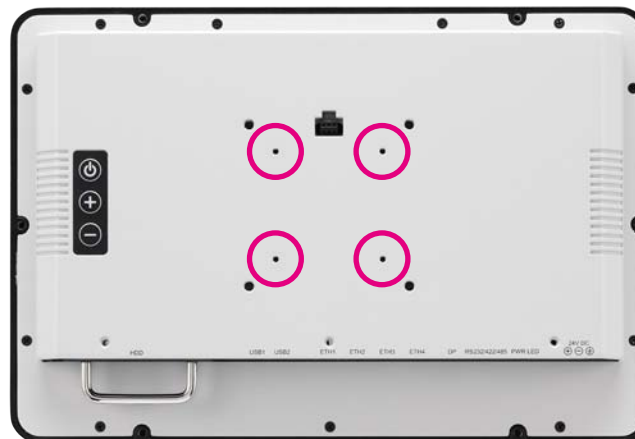

2. Install the fan.



3. Secure the fan with flat head screws.

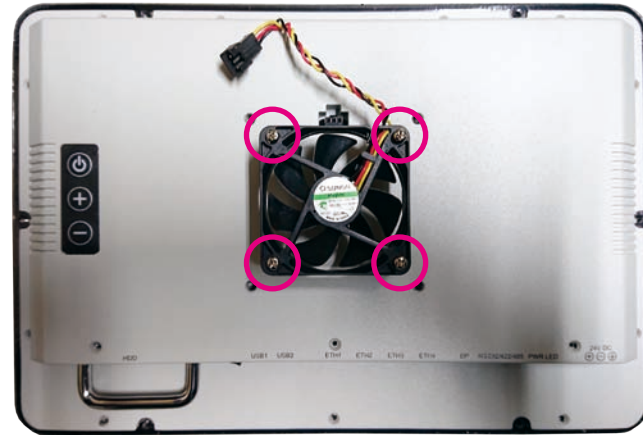

4. Connect the fan cable to the fan connector.



Installing the Flush Mounting Kit (Optional)

The flush mounting kit contains the following items:

- Flush Mount Bracket x 1
- Sponge for Flush Mount Bracket x 1 Set
- Flat Head Screw x 6



Flush Mount Bracket



Sponge for Flush Mount Bracket/Set



Flat Head Screw



The flush mount bracket is used to mount the system on a desk or enclosure.

1. Align the mounting holes on the bracket to the flush mounting holes on the back of the system, then secure the bracket with screws.

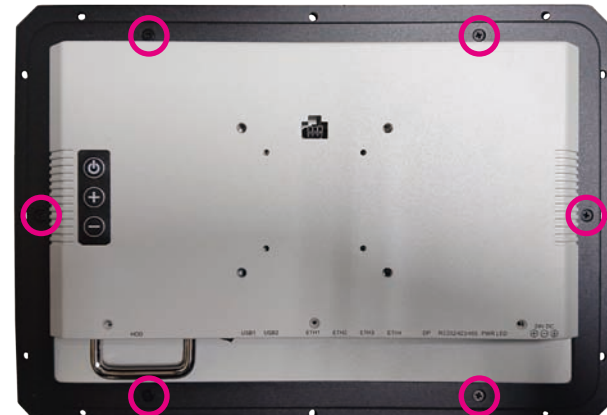
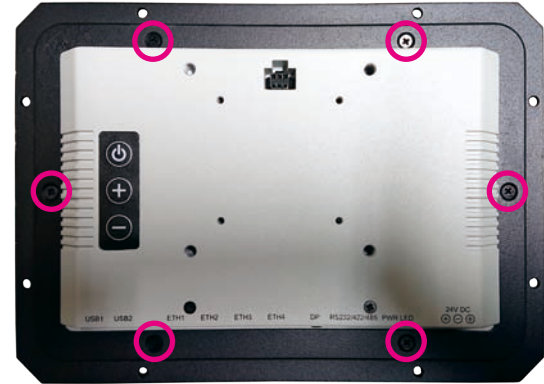

IPPC 0811-B01 Flush Mount Mechanical Dimensions

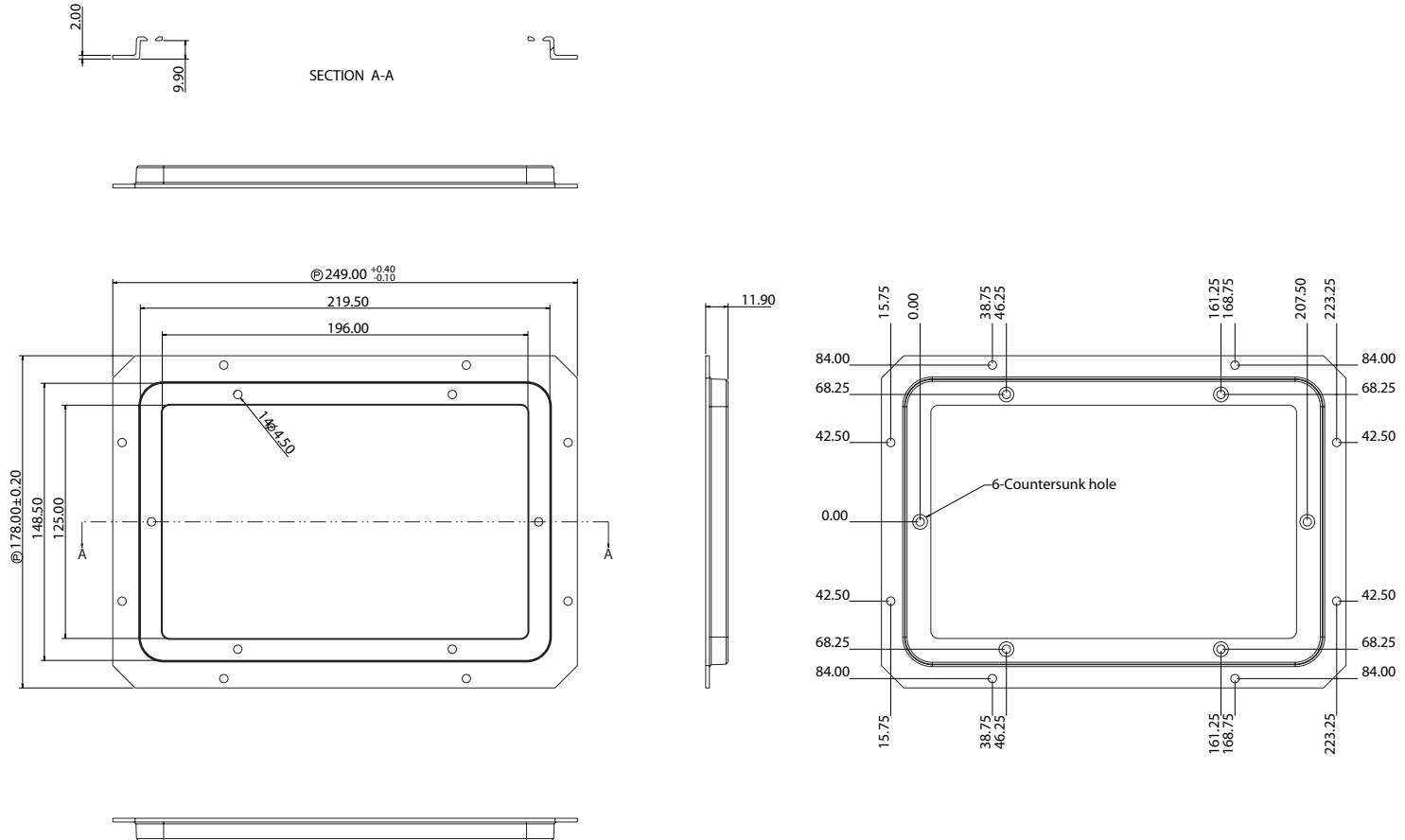

IPPC 1211-B01 Flush Mount Mechanical Dimensions

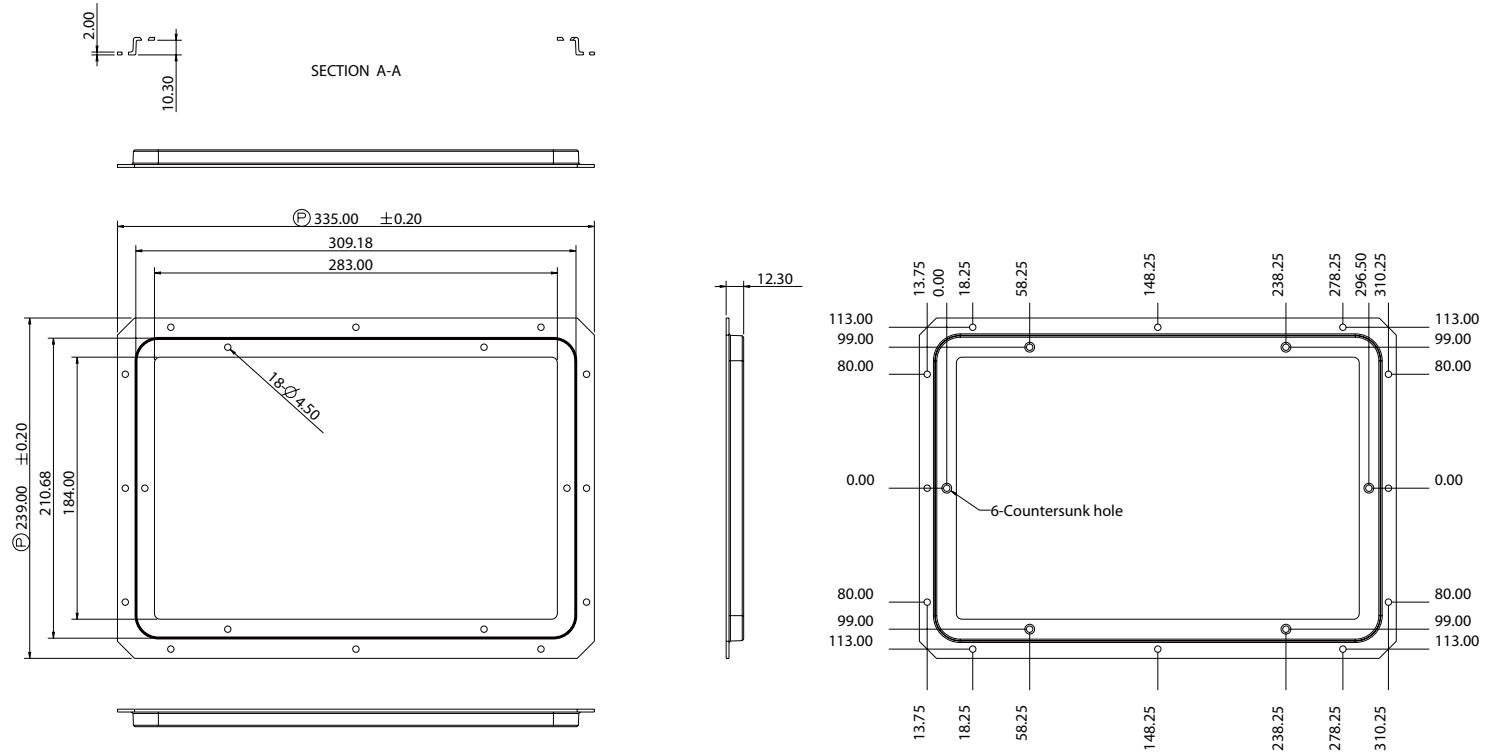

VESA Mounting

1. The VESA mounting measurements are shown as below.

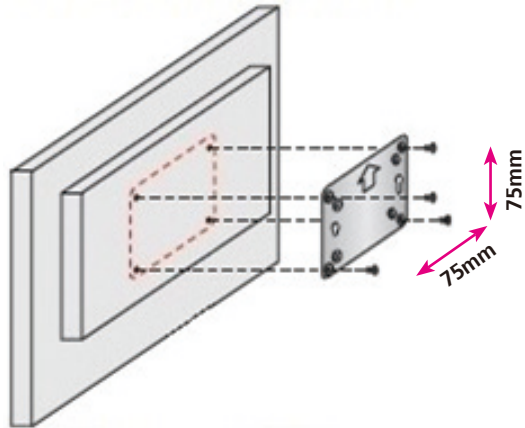

IPPC 0811-B01: 75mm x 75mm

IPPC 1211-B01: 75mm x 75mm

CHAPTER 4: BIOS SETUP

This chapter describes how to use the BIOS setup program for the IPPC 0811-B01 and IPPC 1211-B01. The BIOS screens provided in this chapter are for reference only and may change if the BIOS is updated in the future.

To check for the latest updates and revisions, visit the NexAIoT website at www.nexaiot.com.

About BIOS Setup

The BIOS (Basic Input and Output System) Setup program is a menu driven utility that enables you to make changes to the system configuration and tailor your system to suit your individual work needs. It is a ROM-based configuration utility that displays the system's configuration status and provides you with a tool to set system parameters.

These parameters are stored in non-volatile battery-backed-up CMOS RAM that saves this information even when the power is turned off. When the system is turned back on, the system is configured with the values found in CMOS.

With easy-to-use pull down menus, you can configure items such as:

- Hard drives, diskette drives, and peripherals
- Video display type and display options
- Password protection from unauthorized use
- Power management features

The settings made in the setup program affect how the computer performs. It is important, therefore, first to try to understand all the setup options, and second, to make settings appropriate for the way you use the computer.

When to Configure the BIOS

- This program should be executed under the following conditions:
 - When changing the system configuration
 - When a configuration error is detected by the system and you are prompted to make changes to the setup program
 - When resetting the system clock
 - When redefining the communication ports to prevent any conflicts
 - When making changes to the Power Management configuration
 - When changing the password or making other changes to the security setup

Normally, CMOS setup is needed when the system hardware is not consistent with the information contained in the CMOS RAM, whenever the CMOS RAM has lost power, or the system features need to be changed.

Default Configuration

Most of the configuration settings are either predefined according to the Load Optimal Defaults settings which are stored in the BIOS or are automatically detected and configured without requiring any actions. There are a few settings that you may need to change depending on your system configuration.

Entering Setup











When the system is powered on, the BIOS will enter the Power-On Self Test (POST) routines. These routines perform various diagnostic checks; if an error is encountered, the error will be reported in one of two different ways:

- If the error occurs before the display device is initialized, a series of beeps will be transmitted.
- If the error occurs after the display device is initialized, the screen will display the error message.

Powering on the computer and immediately pressing allows you to enter Setup.

Press the  key to enter Setup:

Legends

Key	Function
	Moves the highlight left or right to select a menu.
	Moves the highlight up or down between sub-menus or fields.
	Exits the BIOS Setup Utility.
	Scrolls forward through the values or options of the highlighted field.
	Scrolls backward through the values or options of the highlighted field.
	Selects a field.
	Displays General Help.
	Load previous values.
	Load optimized default values.
	Saves and exits the Setup program.
	Press <Enter> to enter the highlighted sub-menu

Scroll Bar

When a scroll bar appears to the right of the setup screen, it indicates that there are more available fields not shown on the screen. Use the up and down arrow keys to scroll through all the available fields.

Submenu

When “▶” appears on the left of a particular field, it indicates that a submenu which contains additional options are available for that field. To display the submenu, move the highlight to that field and press  .

BIOS Setup Utility

Once you enter the AMI BIOS Setup Utility, the Main Menu will appear on the screen. The main menu allows you to select from several setup functions and one exit. Use arrow keys to select among the items and press  to accept or enter the submenu.

Main

The Main menu is the first screen that you will see when you enter the BIOS Setup Utility.



System Date

The date format is <day>, <month>, <date>, <year>. Day displays a day, from Monday to Sunday. Month displays the month, from January to December. Date displays the date, from 1 to 31. Year displays the year, from 1999 to 2099.

System Time

The time format is <hour>, <minute>, <second>. The time is based on the 24-hour military-time clock. For example, 1 p.m. is 13:00:00. Hour displays hours from 00 to 23. Minute displays minutes from 00 to 59. Second displays seconds from 00 to 59.

Advanced

The Advanced menu allows you to configure your system for basic operation. Some entries are defaults required by the system board, while others, if enabled, will improve the performance of your system or let you set some features according to your preference.



Setting incorrect field values may cause the system to malfunction.



ACPI Settings

This section is used to configure ACPI Settings.

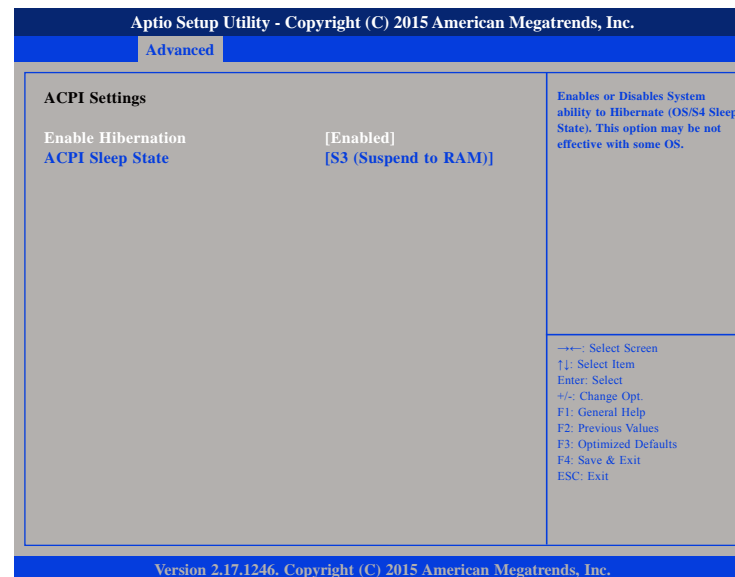

Enable Hibernation

Enables or disables system ability to hibernate (OS/S4 Sleep State). This option may not be effective with some OS.

ACPI Sleep State

Select the highest ACPI sleep state the system will enter when the suspend button is pressed. The options are Suspend Disabled and S3 (Suspend to RAM).

IT8528 Super IO Configuration

This section is used to configure the serial port.

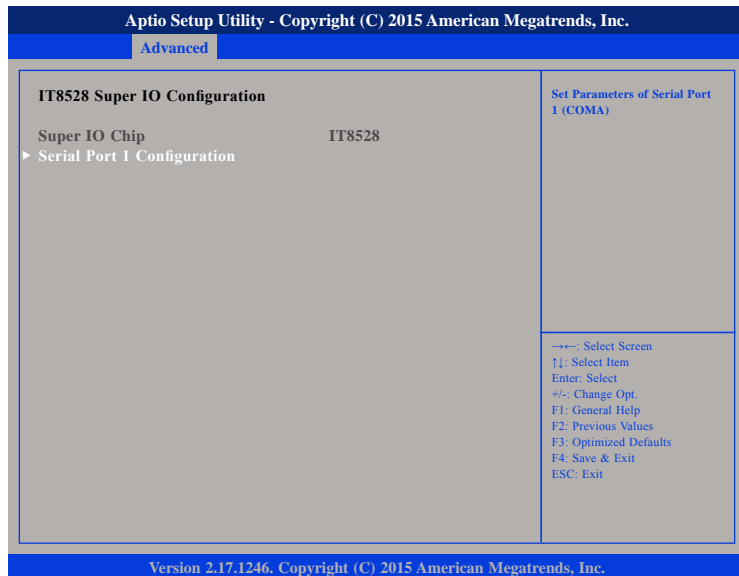

Super IO Chip

Displays the Super I/O chip used on the board.

Serial Port 1 Configuration

This section is used to configure serial port 1.



Serial Port

Enables or disables the serial port.

Onboard Serial Port Mode

Select this to change the serial port mode to RS232, RS422 or RS485.

Terminal 120 Ohm

Enables or disables serial port terminal resistance.

HW Monitor

This section is used to monitor hardware status such as temperature, fan speed and voltages.

The screenshot shows the BIOS 'Advanced' menu with the 'PC Health Status' section. The status is set to '[Automatic Mode]'. The 'FAN Speed 30% under Temp' is set to '[35 C/ 95 F]' and 'FAN Speed 100% above Temp' is set to '[75 C/167 F]'. The hardware status is as follows:

Smart Fan Mode	[Automatic Mode]
FAN Speed 30% under Temp:	[35 C/ 95 F]
FAN Speed 100% above Temp:	[75 C/167 F]
CPU Temperature	: +43 C
System Temperature	: +41 C
Fan1 Speed	: N/A
VCORE	: +0.897 V
+12V	: +12.978 V
5V	: +5.130 V
3.3V	: +3.346 V

Navigation keys listed at the bottom right of the screen:

- ←→: Select Screen
- ↑↓: Select Item
- Enter: Select
- +/-: Change Opt.
- F1: General Help
- F2: Previous Values
- F3: Optimized Defaults
- F4: Save & Exit
- ESC: Exit

Version 2.17.1246. Copyright (C) 2015 American Megatrends, Inc.

Smart Fan Mode

Selects the mode of the fan, the options are Full on Mode and Automatic Mode.

FAN Speed 30% under Temp

Configures the temperature for the fan speed to operate at 30% efficiency.

CPU Temperature

Detects and displays the current CPU temperature.

System Temperature

Detects and displays the current system temperature.

Fan1 Speed

Detects and displays the current fan1 speed.

VCORE

Detects and displays the Vcore CPU voltage.

+12V

Detects and displays the 12V voltage.

5V

Detects and displays the 5V voltage.

3.3V

Detects and displays the 3.3V voltage.

CPU Configuration

This section is used to configure the CPU.



Limit CPUID Maximum

The CPUID instruction of some newer CPUs will return a value greater than 3. The default is Disabled because this problem does not exist in the Windows series operating systems. If you are using an operating system other than Windows, this problem may occur. To avoid this problem, enable this field to limit the return value to 3 or lesser than 3.

Execute Disable Bit

When this field is set to Disabled, it will force the XD feature flag to always return to 0. XD can prevent certain classes of malicious buffer overflow attacks when combined with a supporting OS (Windows Server 2003 SP1, Windows XP SP2, SuSE Linux 9.2, RedHat Enterprise 3 Update 3).

Intel® Virtualization Technology

Enables or disables Intel Virtualization technology.

Power Technology

Configures the power management features.

Socket 0 CPU Information

Display information on the CPU installed on socket 0.

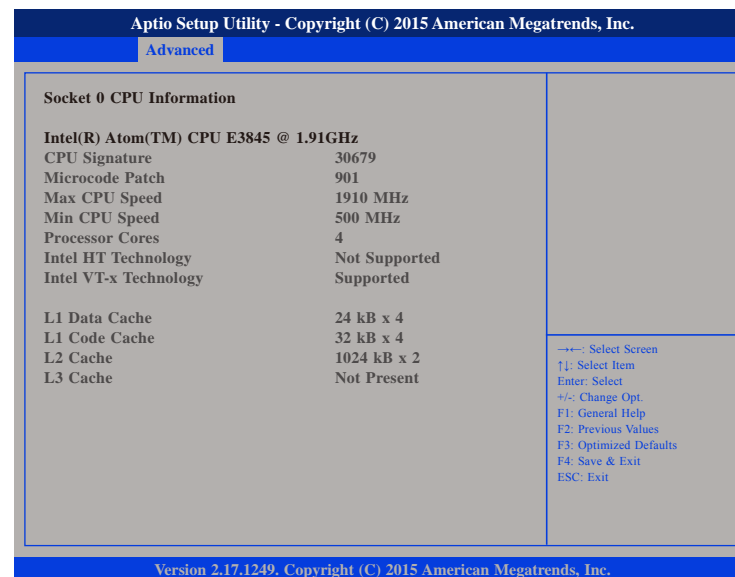

IDE Configuration

This section is used to configure the SATA drives.



Serial-ATA (SATA)

Enables or disables the SATA controller.

SATA ODD Port

Configures SATA port 0 or port 1 as the SATA optical disc drive (ODD).

SATA Mode

Configures the SATA as IDE or AHCI mode.

IDE This option configures the Serial ATA drives as Parallel ATA physical storage device.

AHCI This option configures the Serial ATA drives to use AHCI (Advanced Host Controller Interface). AHCI allows the storage driver to enable the advanced Serial ATA features which will increase storage performance.

Serial-ATA Port 0

Enables or disables SATA port 0.

SATA Port0 HotPlug

Enables or disables hot pluggable support on SATA port 0.

Serial-ATA Port 1

Enables or disables SATA port 1.

SATA Port1 HotPlug

Enables or disables hot pluggable support on SATA port 1.

AMI Graphic Output Protocol Policy

This section is used to configure the graphics controller settings.

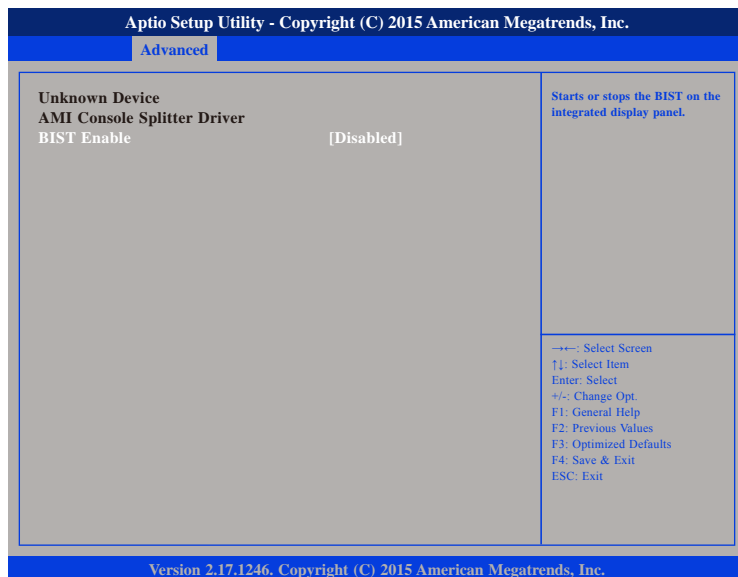

BIST Enable

Enables or disables the BIST (Built-in-Self-Test) on the integrated display panel.

USB Configuration

This section is used to configure the USB.

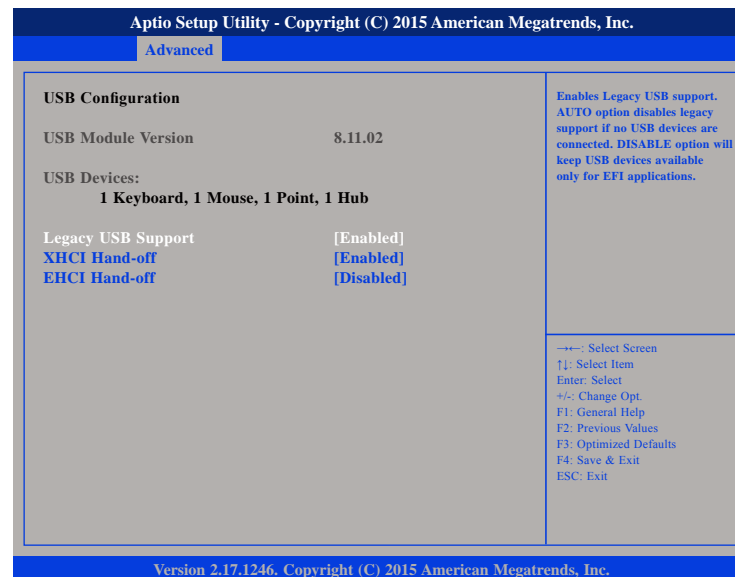

Legacy USB Support

Enable Enables Legacy USB.

Auto Disables support for Legacy when no USB devices are connected.

Disable Keeps USB devices available only for EFI applications.

XHCI Hand-off and EHCI Hand-off

This is a workaround for OSs that does not support XHCI hand-off and EHCI Hand-off. The XHCI and EHCI ownership change should be claimed by the XHCI and EHCI driver respectively.

Chipset

This section is used to configure the system based on the specific features of the chipset.



Setting incorrect field values may cause the system to malfunction.

South Bridge



High Precision Timer

Enables or disables high precision event timer.

Restore AC Power Loss

Select the AC power state when power is re-applied after a power failure.

Global SMI Lock

Enables or disables global SMI lock.

BIOS Read/Write Protection

Enables or disables BIOS SPI region read/write protect.

USB Configuration

Aptio Setup Utility - Copyright (C) 2015 American Megatrends, Inc.		
Chipset		
USB Configuration		Control the USB EHCI (USB 2.0) functions. One EHCI controller must always be enabled.
XHCI Mode	[Disabled]	
USB 2.0(EHCI) Support	[Enabled]	
USB EHCI debug	[Disabled]	
		→←: Select Screen ↑↓: Select Item Enter: Select +/-: Change Opt. F1: General Help F2: Previous Values F3: Optimized Defaults F4: Save & Exit ESC: Exit
Version 2.17.1246. Copyright (C) 2015 American Megatrends, Inc.		

USB 2.0(EHCI) Support

Enables or disables the Enhanced Host Controller Interface (USB 2.0), one EHCI controller must always be enabled.

USB EHCI Debug

Enables or disables PCH EHCI debug capability.

PCI Express Configuration

Aptio Setup Utility - Copyright (C) 2015 American Megatrends, Inc.		
Chipset		
PCI Express Configuration		Enable or Disable the PCI Express Port 0 in the Chipset.
PCI Express Port 0	[Enabled]	
Hot Plug	[Enabled]	
PCI Express Port 1	[Enabled]	
Hot Plug	[Enabled]	
PCI Express Port 2	[Enabled]	
Hot Plug	[Enabled]	
PCI Express Port 3	[Enabled]	
Hot Plug	[Enabled]	
		→←: Select Screen ↑↓: Select Item Enter: Select +/-: Change Opt. F1: General Help F2: Previous Values F3: Optimized Defaults F4: Save & Exit ESC: Exit
Version 2.17.1246. Copyright (C) 2015 American Megatrends, Inc.		

PCI Express Port 0 to PCI Express Port 3

Enables or disables PCI Express ports 0 to 3 on the chipset.

Hot Plug

Enables or disables PCI Express hot-plug support for ports 0 to 3.

Security

Aptio Setup Utility - Copyright (C) 2015 American Megatrends, Inc.						
Main	Advanced	Chipset	Security	Boot	Save & Exit	
<p>Password Description</p> <p>If ONLY the Administrator's password is set, then this only limits access to Setup and is only asked for when entering Setup. If ONLY the User's password is set, then this is a power on password and must be entered to boot or enter Setup. In Setup the User Will have Administrator rights. The password length must be in the following range:</p> <table> <tr> <td>Minimum length</td> <td>3</td> </tr> <tr> <td>Maximum length</td> <td>20</td> </tr> </table> <p>Administrator Password User Password</p>		Minimum length	3	Maximum length	20	<p>Set Administrator Password</p>
Minimum length	3					
Maximum length	20					
		<p>←→: Select Screen ↑↓: Select Item Enter: Select +/-: Change Opt. F1: General Help F2: Previous Values F3: Optimized Defaults F4: Save & Exit ESC: Exit</p>				
Version 2.17.1246. Copyright (C) 2015 American Megatrends, Inc.						

Administrator Password

Select this to reconfigure the administrator's password.

User Password

Select this to reconfigure the user's password.

Boot

Aptio Setup Utility - Copyright (C) 2015 American Megatrends, Inc.					
Main	Advanced	Chipset	Security	Boot	Save & Exit
<p>Boot Configuration</p> <p>Bootup NumLock State [On] Fast Boot [Disabled]</p> <p>Network PXE [Disabled]</p> <p>Boot Option Priorities</p> <p>Boot Option #1 [P0: TS128GMTS400 . . .] Boot Option #2 [UEFI: Built-in EFI . . .]</p> <p>Hard Drive BBS Priorities</p>		<p>Select the keyboard NumLock state</p>			
		<p>←→: Select Screen ↑↓: Select Item Enter: Select +/-: Change Opt. F1: General Help F2: Previous Values F3: Optimized Defaults F4: Save & Exit ESC: Exit</p>			
Version 2.17.1246. Copyright (C) 2015 American Megatrends, Inc.					

Bootup NumLock State

This allows you to determine the default state of the numeric keypad. By default, the system boots up with NumLock on wherein the function of the numeric keypad is the number keys. When set to Off, the function of the numeric keypad is the arrow keys.

Fast Boot

When enabled, the BIOS will shorten or skip some check items during POST. This will decrease the time needed to boot the system.

Network PXE

Controls the execution of UEFI and legacy PXE OpROM.

Boot Option Priorities

Adjust the boot sequence of the system. Boot Option #1 is the first boot device that the system will boot from, next will be #2 and so forth.

Save & Exit



Save Changes and Reset

To save the changes and reset, select this field then press <Enter>. A dialog box will appear. Confirm by selecting Yes.

Discard Changes and Reset

To exit the Setup utility and reset without saving the changes, select this field then press <Enter>. You may be prompted to confirm again before exiting.

Restore Defaults

To restore the BIOS to default settings, select this field then press <Enter>. A dialog box will appear. Confirm by selecting Yes.

APPENDIX A: POWER CONSUMPTION

Power Consumption Management

Purpose

The purpose of the power consumption test is to verify the power dissipation of the system and the load of the power supply.

Test Data

System	Sys#1 IPPC 0811-B01	Sys#2 IPPC 1211-B01
Modes	+24V	+24V
Sleep Mode	0.09A	0.07A
Total Watts	2.16W	1.68W
Idle Mode	0.63A	0.9A
Total Watts	15.12W	21.6W
Full-Loading Mode	0.75A	1.05A
Total Watts	18W	25.2W

APPENDIX B: WATCHDOG

1.1 Command Register and Address Description:

Command	Description
0x88	Read watchdog time interval
0x89	Reset watchdog time interval
0x28	Start watchdog
0x29	Stop watchdog
0x2A	Reset watchdog

Address for watchdog:

Watchdog is used to set up time interval and also keep event status. Unit time interval is 1ms. Time setting requires a word (8 bit) long length. You can set up watchdog event time from 0 to 0xFFFFFFFF. Write 0xFFFFFFFF to time interval setting means disable watchdog event. The interval time range is from 0ms to 497 day (0~0xFFFFFFFF)

Address	Description
0x50-0x53	0~0xFFFFFFFF

1.2 Set up Watchdog Time Interval Description:

Step	Action	Description	RW Sample Code Command
0	Wait IBF clear		x
1	Write 0x89 to 0x66	Send read command	>o 0x66 0x89
2	Wait IBF clear		x
3	Write RAM address to 0x62 port	Send Watchdog address 0x50~0x53.	>o 0x62 0x50
4	Wait OBF set		x
5	Write watchdog time interval value to 0x62	Values from 0~0xFFFFFFFF, but two bit in each address, please refer to sample code explanation.	>o 0x62 0x90

Sample explanation:

To set up watchdog time interval to 4 seconds, here are the values that should be filled in each address.

4sec = 400ms (decimal) = 190 (hexadecimal)

Address	0x50	0x51	0x52	0x53
Data	0x00	0x00	0x01	0x90

Complete command set sequence:

Further Description	Command	Address	Data
Set watchdog interval, write to address 0x50~0x53 and Data "00000190"	①>o 0x66 0x89	②>o 0x62 0x50	③>o 0x00
	④>o 0x66 0x89	⑤>o 0x62 0x51	⑥>o 0x00
	⑦>o 0x66 0x89	⑧>o 0x62 0x52	⑨>o 0x01
	⑩>o 0x66 0x89	⑪>o 0x62 0x53	⑫>o 0x90

1.3 Read Watchdog Time Interval Description:

Step	Action	Description	RW Sample Code Command
0	Wait IBF clear		x
1	Write 0x88 to 0x66	Send read command	>o 0x66 0x88
2	Wait IBF clear		x
3	Write RAM address to 0x62 port	Send watchdog address 0x50~0x53	>o 0x62 0x50
4	Wait OBF set		x
5	Read 0x62 port	Get Light sensor data in current address	>i 0x62

Please note different address cannot read continuously, you should run read command steps all over again till the last address location.

Further Description	Command	Address	Read
Send cmd to read address 0x50	①>o 0x66 0x88	②>o 0x62 0x50	③>i 0x62
Send cmd to read address 0x51	④>o 0x66 0x88	⑤>o 0x62 0x51	⑥>i 0x62
Send cmd to read address 0x52	⑦>o 0x66 0x88	⑧>o 0x62 0x52	⑨>i 0x62
Send cmd to read address 0x53	⑩>o 0x66 0x88	⑪>o 0x62 0x53	⑫>i 0x62

To complete read 0x50 ~ 0x53 address, you have to complete the commands from 1~12.

1.4 Reset Watchdog Time Interval Description:

This command is used to reset watchdog time.

Step	Action	Description	RW Sample Code Command
0	Wait IBF clear		x
1	Write 0x2A to 0x66	Send reset watchdog command	>o 0x66 0x2A
2	Wait OBF set		x
3	Read 0x62 port	If setup successfully, EC will return 0x03.	x (check 0x03 output on display)

1.5 Start Watchdog Description:

Step	Action	Description	RW Sample Code Command
0	Wait IBF clear		x
1	Write 0x28 to 0x66	Send start watchdog command	>o 0x66 0x28
2	Wait IBF clear		x
3	Write 0x01 to 0x62		>o 0x62 0x01 (check 0x03 output on display)
4	Wait OBF set		x
5	Read 0x62 port	If setup successfully, EC will return 0x01.	x (check 0x01 output on display)

1.6 Stop Watchdog Description:

Step	Action	Description	RW Sample Code Command
0	Wait IBF clear		x
1	Write 0x29 to 0x66	Send stop watchdog command	>o 0x66 0x29
2	Wait OBF set		x
3	Read 0x62 port	If setup successfully, EC will return 0x02.	x (check 0x02 output on display)